



# CATÁLOGO TÉCNICO





70  
A N O S

SABÓ. A MARCA QUE É  
REFERÊNCIA MUNDIAL.

Sabó é referência em inovação por trabalhar com a mais alta tecnologia, em qualidade por oferecer produtos de alto padrão, e em criatividade no desenvolvimento de sistemas automotivos. Em outras palavras, Sabó é o resultado do compromisso com o mercado e talento para oferecer sempre as soluções mais inovadoras. Ela representa não só uma história de tradição mas, principalmente, uma evolução contínua e atuação integrada e sinérgica em todo o planeta. Onde a marca Sabó estiver, pode ter certeza: ali estarão as soluções do futuro.



SÃO PAULO - BRASIL



MOGI MIRIM - BRASIL



LINCOLNTON - EUA



BUENOS AIRES - ARGENTINA



ST. MICHAEL - ÁUSTRIA



# ATUAÇÃO LOCAL, VISÃO GLOBAL.

A Sabó está presente nos maiores centros de produção e desenvolvimento de tecnologia automobilística do mundo. Tudo para garantir seu compromisso com as demandas e necessidades de seus clientes. Por isso, a Sabó não para de se expandir e de consolidar sua posição global de multinacional, fazendo da proximidade do cliente seu diferencial.

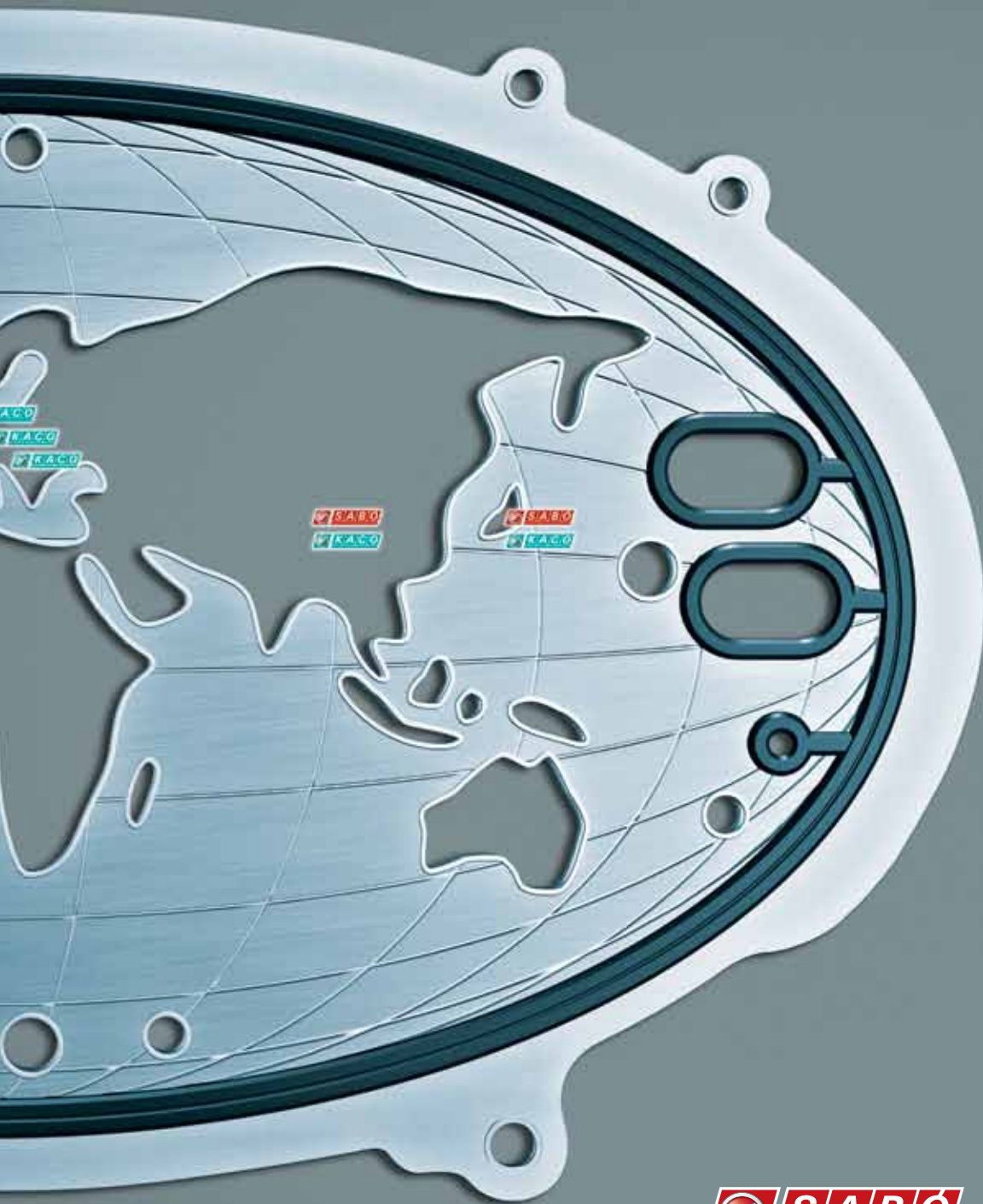

HEILBRONN - ALEMANHA



KIRCHARDT - ALEMANHA



TALHEIM - ALEMANHA



ENESE - HUNGRIA



WUXI - CHINA



Grupo Sabó

As atividades integradas em tempo real e o intercâmbio de informações entre suas unidades do Brasil e do exterior garantem um padrão mundial de processo, qualidade e tecnologia, e capacitam cada vez mais a Sabó a ser a fornecedora preferencial das principais montadoras mundiais e a exportar soluções inovadoras, qualidade e serviço para mais de 40 países.

# LIDERANDO AS SOLUÇÕES DO FUTURO.

Todos os integrantes do processo produtivo da Sabó, em qualquer parte do mundo, têm a mesma filosofia: buscar sempre a tecnologia da perfeição. Assim, a Sabó oferece produtos state-of-the-art e autocertificados com muito mais qualidade. Esse pensamento global, aliado a uma forte atuação local, são complementados por investimentos em equipamentos de projetos e testes, softwares de última geração, qualificação profissional, pesquisa de materiais e engenharia avançada. Um conjunto de recursos que garante, em todas as fábricas da Sabó, certificação de qualidade conferida pelos mais rígidos padrões existentes.

# RELAÇÕES DE VALOR COM O MERCADO.

Relacionamento, qualificação e negócios são os pilares dos programas inovadores criados e implementados pela Sabó junto aos seus públicos, para que eles prosperem cada vez mais em suas áreas de atuação. Investir em qualificação e reconhecer o mercado pelo seu compromisso e fidelidade com a Sabó, significa investir também no futuro do nosso próprio negócio. Tanto que é da Sabó o pacote de serviços mais inovador e referência de mercado. Ele inclui sucessos consagrados como o Top Performance, Desempenho Sabó, o Caderninho Sabó, além dos Consultores Técnicos e dos Promotores, que garantem apoio integral aos profissionais.



Grupo Sabó



# ÍNDICE

	Página
COMO UTILIZAR ESSE CATÁLOGO	11
FUNÇÃO DO RETENTOR	12
CARACTERÍSTICAS DO LÁBIO DE VEDAÇÃO	12
MATERIAIS ELASTOMÉRICOS	13
RECOMENDAÇÕES QUANTO À APLICAÇÃO	14
RECOMENDAÇÕES QUANTO À SUPERFÍCIE DO EIXO	15
RECOMENDAÇÕES QUANTO ÀS CONDIÇÕES DE MONTAGEM	16
NORMATIZAÇÃO DE MEDIDAS DOS RETENTORES SEGUNDO A NORMA DIN 3761	17
CONCEITOS BÁSICOS DE CONSTRUÇÃO	18
ILUSTRAÇÕES TIPOS BÁSICOS E LEGENDA	20
TIPOS BÁSICOS - TB	21
GRUPO A - RETENTORES ALTERNATIVOS	32
GRUPO B - RETENTORES DUAS ALTURAS	34
GRUPO C - RETENTORES PARA SISTEMAS HIDRÁULICOS	34
GRUPO D - RETENTORES PARA MOVIMENTO AXIAL	35
GRUPO E - PISTA PARA RETENTORES	35
GRUPO F - RETENTORES PARA HASTE DE VÁLVULAS	36
GRUPO G - RETENTORES PARA VEDAÇÃO EXTERNA	37
GRUPO H - RETENTORES TAMPÃO	37
GRUPO I - RETENTORES COMPOSTOS EM KITS	38
GRUPO J - ARRUELA PARA VEDAÇÃO	38

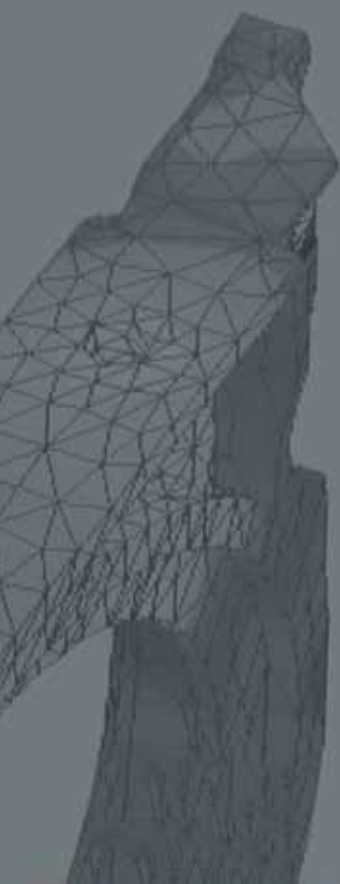

# ÍNDICE

	<b>Página</b>
GRUPO K - RETENORES COM ABA NO EXTERNO	<b>39</b>
GRUPO L - RETENORES INTEGRADOS	<b>39</b>
GRUPO M - RETENORES COM PISTA PRÓPRIA	<b>40</b>
GRUPO N - RETENORES SOMENTE DE BORRACHA	<b>40</b>
GRUPO O - RETENORES FIXADOS POR PARAFUSOS	<b>41</b>
GRUPO P - RETENORES DE METAL E FELTRO	<b>41</b>
GRUPO Q - RETENORES DE FELTRO	<b>41</b>
GRUPO R - RETENORES ESTAMPADOS	<b>42</b>
GRUPO S - RETENORES COM LÁBIO DE VEDAÇÃO EM PTFE	<b>42</b>
GRUPO T - SISTEMAS INTEGRADOS DE VEDAÇÃO	<b>43</b>
GRUPO U - RETENORES TIPO "S"	<b>43</b>
ILUSTRAÇÕES TIPOS ALTERNATIVOS/ ESPECIAIS	<b>44</b>
ÍNDICE ALFANUMÉRICO (ORDEM CRESCENTE Nº SABÓ)	<b>54</b>



COMO UTILIZAR ESTE CATÁLOGO

COMO UTILIZAR ESTE CATÁLOGO

Para facilitar a sua consulta, os retentores deste manual foram divididos de acordo com os tipos (básicos, alternativos e especiais). Todas as seções começam com as ilustrações dos retentores em corte. Nas páginas seguintes, todos os dados técnicos, conforme a explicação abaixo.

COMO LOCALIZAR O RETENTOR DESEJADO

1 - Tipos Básicos (páginas 20 a 31)

Conhecendo o diâmetro do eixo, localizá-lo na primeira coluna "Diâmetro do Eixo". Nesta mesma linha, você encontrará as informações complementares: diâmetro do alojamento, altura do retentor, número Sabó, tipo, orientação, material do lábio e a página onde está a figura do retentor em questão.

2 - Tipos Alternativos (páginas 32 a 33) e Especiais (páginas 34 a 43)

Cada grupo recebe o nome da função a que se destina o retentor. Procure entre os Grupos A/U o perfil do retentor desejado. Depois, conhecendo o diâmetro do eixo, localize as informações complementares, na mesma linha. As ilustrações antecedem as informações técnicas. Você encontra as figuras dos retentores dos tipos Alternativos nas página 44 a 45 e as figuras dos tipos Especiais nas páginas 46 a 53.

3 - Índice

Conhecendo-se o número Sabó, localize-o no índice numérico onde encontrará o diâmetro do eixo. Caso o retentor encontrado seja tipo alternativo ou tipo especial, estará indicado o grupo a que pertence. Para informações complementares, proceder conforme descrito acima nos itens 1 e 2.

4 - Índice Alfanumérico

Conhecendo o número Sabó, localize-o no índice Alfanumérico, onde você encontrará também o diâmetro do eixo. Caso o retentor procurado seja do tipo alternativo ou especial, estará indicado o grupo a que pertence. Para informações complementares, proceder como descrito nos itens 1 e 2.

CATÁLOGO TÉCNICO

GRUPO BÁSICOS

TIPOS BÁSICOS

Diâmetro do Eixo	Diâmetro do Alojamento	Altura do Retentor	Número Sabó	Grupo	Orientação	Material do Lábio	Página
17,0	20,0	7,0	8004	L2	NBR	BT100000A	20
17,0	20,1	8,0	8005	L2	NBR	BT100000B	20
17,0	20,2	9,0	8006	L2	NBR	BT100000C	20
17,0	20,3	10,0	8007	L2	NBR	BT100000D	20
17,0	20,4	11,0	8008	L2	NBR	BT100000E	20
17,0	20,5	12,0	8009	L2	NBR	BT100000F	20
17,0	20,6	13,0	8010	L2	NBR	BT100000G	20
17,0	20,7	14,0	8011	L2	NBR	BT100000H	20
17,0	20,8	15,0	8012	L2	NBR	BT100000I	20
17,0	20,9	16,0	8013	L2	NBR	BT100000J	20
17,0	21,0	17,0	8014	L2	NBR	BT100000K	20
17,0	21,1	18,0	8015	L2	NBR	BT100000L	20
17,0	21,2	19,0	8016	L2	NBR	BT100000M	20
17,0	21,3	20,0	8017	L2	NBR	BT100000N	20
17,0	21,4	21,0	8018	L2	NBR	BT100000O	20
17,0	21,5	22,0	8019	L2	NBR	BT100000P	20
17,0	21,6	23,0	8020	L2	NBR	BT100000Q	20
17,0	21,7	24,0	8021	L2	NBR	BT100000R	20
17,0	21,8	25,0	8022	L2	NBR	BT100000S	20
17,0	21,9	26,0	8023	L2	NBR	BT100000T	20
17,0	22,0	27,0	8024	L2	NBR	BT100000U	20
17,0	22,1	28,0	8025	L2	NBR	BT100000V	20
17,0	22,2	29,0	8026	L2	NBR	BT100000W	20
17,0	22,3	30,0	8027	L2	NBR	BT100000X	20
17,0	22,4	31,0	8028	L2	NBR	BT100000Y	20
17,0	22,5	32,0	8029	L2	NBR	BT100000Z	20
17,0	22,6	33,0	8030	L2	NBR	BT100000A	21
17,0	22,7	34,0	8031	L2	NBR	BT100000B	21
17,0	22,8	35,0	8032	L2	NBR	BT100000C	21
17,0	22,9	36,0	8033	L2	NBR	BT100000D	21
17,0	23,0	37,0	8034	L2	NBR	BT100000E	21
17,0	23,1	38,0	8035	L2	NBR	BT100000F	21
17,0	23,2	39,0	8036	L2	NBR	BT100000G	21
17,0	23,3	40,0	8037	L2	NBR	BT100000H	21
17,0	23,4	41,0	8038	L2	NBR	BT100000I	21
17,0	23,5	42,0	8039	L2	NBR	BT100000J	21
17,0	23,6	43,0	8040	L2	NBR	BT100000K	21
17,0	23,7	44,0	8041	L2	NBR	BT100000L	21
17,0	23,8	45,0	8042	L2	NBR	BT100000M	21
17,0	23,9	46,0	8043	L2	NBR	BT100000N	21
17,0	24,0	47,0	8044	L2	NBR	BT100000O	21
17,0	24,1	48,0	8045	L2	NBR	BT100000P	21
17,0	24,2	49,0	8046	L2	NBR	BT100000Q	21
17,0	24,3	50,0	8047	L2	NBR	BT100000R	21
17,0	24,4	51,0	8048	L2	NBR	BT100000S	21
17,0	24,5	52,0	8049	L2	NBR	BT100000T	21
17,0	24,6	53,0	8050	L2	NBR	BT100000U	21
17,0	24,7	54,0	8051	L2	NBR	BT100000V	21
17,0	24,8	55,0	8052	L2	NBR	BT100000W	21
17,0	24,9	56,0	8053	L2	NBR	BT100000X	21
17,0	25,0	57,0	8054	L2	NBR	BT100000Y	21
17,0	25,1	58,0	8055	L2	NBR	BT100000Z	21
17,0	25,2	59,0	8056	L2	NBR	BT100000A	22
17,0	25,3	60,0	8057	L2	NBR	BT100000B	22
17,0	25,4	61,0	8058	L2	NBR	BT100000C	22
17,0	25,5	62,0	8059	L2	NBR	BT100000D	22
17,0	25,6	63,0	8060	L2	NBR	BT100000E	22
17,0	25,7	64,0	8061	L2	NBR	BT100000F	22
17,0	25,8	65,0	8062	L2	NBR	BT100000G	22
17,0	25,9	66,0	8063	L2	NBR	BT100000H	22
17,0	26,0	67,0	8064	L2	NBR	BT100000I	22
17,0	26,1	68,0	8065	L2	NBR	BT100000J	22
17,0	26,2	69,0	8066	L2	NBR	BT100000K	22
17,0	26,3	70,0	8067	L2	NBR	BT100000L	22
17,0	26,4	71,0	8068	L2	NBR	BT100000M	22
17,0	26,5	72,0	8069	L2	NBR	BT100000N	22
17,0	26,6	73,0	8070	L2	NBR	BT100000O	22
17,0	26,7	74,0	8071	L2	NBR	BT100000P	22
17,0	26,8	75,0	8072	L2	NBR	BT100000Q	22
17,0	26,9	76,0	8073	L2	NBR	BT100000R	22
17,0	27,0	77,0	8074	L2	NBR	BT100000S	22
17,0	27,1	78,0	8075	L2	NBR	BT100000T	22
17,0	27,2	79,0	8076	L2	NBR	BT100000U	22
17,0	27,3	80,0	8077	L2	NBR	BT100000V	22
17,0	27,4	81,0	8078	L2	NBR	BT100000W	22
17,0	27,5	82,0	8079	L2	NBR	BT100000X	22
17,0	27,6	83,0	8080	L2	NBR	BT100000Y	22
17,0	27,7	84,0	8081	L2	NBR	BT100000Z	22
17,0	27,8	85,0	8082	L2	NBR	BT100000A	23
17,0	27,9	86,0	8083	L2	NBR	BT100000B	23
17,0	28,0	87,0	8084	L2	NBR	BT100000C	23
17,0	28,1	88,0	8085	L2	NBR	BT100000D	23
17,0	28,2	89,0	8086	L2	NBR	BT100000E	23
17,0	28,3	90,0	8087	L2	NBR	BT100000F	23
17,0	28,4	91,0	8088	L2	NBR	BT100000G	23
17,0	28,5	92,0	8089	L2	NBR	BT100000H	23
17,0	28,6	93,0	8090	L2	NBR	BT100000I	23
17,0	28,7	94,0	8091	L2	NBR	BT100000J	23
17,0	28,8	95,0	8092	L2	NBR	BT100000K	23
17,0	28,9	96,0	8093	L2	NBR	BT100000L	23
17,0	29,0	97,0	8094	L2	NBR	BT100000M	23
17,0	29,1	98,0	8095	L2	NBR	BT100000N	23
17,0	29,2	99,0	8096	L2	NBR	BT100000O	23
17,0	29,3	100,0	8097	L2	NBR	BT100000P	23
17,0	29,4	101,0	8098	L2	NBR	BT100000Q	23
17,0	29,5	102,0	8099	L2	NBR	BT100000R	23
17,0	29,6	103,0	8100	L2	NBR	BT100000S	23
17,0	29,7	104,0	8101	L2	NBR	BT100000T	23
17,0	29,8	105,0	8102	L2	NBR	BT100000U	23
17,0	29,9	106,0	8103	L2	NBR	BT100000V	23
17,0	30,0	107,0	8104	L2	NBR	BT100000W	23
17,0	30,1	108,0	8105	L2	NBR	BT100000X	23
17,0	30,2	109,0	8106	L2	NBR	BT100000Y	23
17,0	30,3	110,0	8107	L2	NBR	BT100000Z	23
17,0	30,4	111,0	8108	L2	NBR	BT100000A	24
17,0	30,5	112,0	8109	L2	NBR	BT100000B	24
17,0	30,6	113,0	8110	L2	NBR	BT100000C	24
17,0	30,7	114,0	8111	L2	NBR	BT100000D	24
17,0	30,8	115,0	8112	L2	NBR	BT100000E	24
17,0	30,9	116,0	8113	L2	NBR	BT100000F	24
17,0	31,0	117,0	8114	L2	NBR	BT100000G	24
17,0	31,1	118,0	8115	L2	NBR	BT100000H	24
17,0	31,2	119,0	8116	L2	NBR	BT100000I	24
17,0	31,3	120,0	8117	L2	NBR	BT100000J	24
17,0	31,4	121,0	8118	L2	NBR	BT100000K	24
17,0	31,5	122,0	8119	L2	NBR	BT100000L	24
17,0	31,6	123,0	8120	L2	NBR	BT100000M	24
17,0	31,7	124,0	8121	L2	NBR	BT100000N	24
17,0	31,8	125,0	8122	L2	NBR	BT100000O	24
17,0	31,9	126,0	8123	L2	NBR	BT100000P	24
17,0	32,0	127,0	8124	L2	NBR	BT100000Q	24
17,0	32,1	128,0	8125	L2	NBR	BT100000R	24
17,0	32,2	129,0	8126	L2	NBR	BT100000S	24
17,0	32,3	130,0	8127	L2	NBR	BT100000T	24
17,0	32,4	131,0	8128	L2	NBR	BT100000U	24
17,0	32,5	132,0	8129	L2	NBR	BT100000V	24
17,0	32,6	133,0	8130	L2	NBR	BT100000W	24
17,0	32,7	134,0	8131	L2	NBR	BT100000X	24
17,0	32,8	135,0	8132	L2	NBR	BT100000Y	24
17,0	32,9	136,0	8133	L2	NBR	BT100000Z	24
17,0	33,0	137,0	8134	L2	NBR	BT100000A	25
17,0	33,1	138,0	8135	L2	NBR	BT100000B	25
17,0	33,2	139,0	8136	L2	NBR	BT100000C	25
17,0	33,3	140,0	8137	L2	NBR	BT100000D	25
17,0	33,4	141,0	8138	L2	NBR	BT100000E	25
17,0	33,5	142,0	8139	L2	NBR	BT100000F	25
17,0	33,6	143,0	8140	L2	NBR	BT100000G	25
17,0	33,7	144,0	8141	L2	NBR	BT100000H	25
17,0	33,8	145,0	8142	L2	NBR	BT100000I	25
17,0	33,9	146,0	8143	L2	NBR	BT100000J	25
17,0	34,0	147,0	8144	L2	NBR	BT100000K	25
17,0	34,1	148,0	8145	L2	NBR	BT100000L	25
17,0	34,2	149,0	8146	L2	NBR	BT100000M	25
17,0	34,3	150,0	8147	L2	NBR	BT100000N	25
17,0	34,4	151,0	8148	L2	NBR	BT100000O	25
17,0	34,5	152,0	8149	L2	NBR	BT100000P	25
17,0	34,6	153,0	8150	L2	NBR	BT100000Q	25
17,0	34,7	154,0	8151	L2	NBR	BT100000R	25
17,0	34,8	155,0	8152	L2	NBR	BT100000S	25
17,0	34,9	156,0	8153	L2	NBR	BT100000T	25
17,0	35,0	157,0	8154	L2	NBR	BT100000U	25
17,0	35,1	158,0	8155	L2	NBR	BT100000V	25
17,0	35,2	159,0	8156	L2	NBR	BT100000W	25
17,0	35,3	160,0	8157	L2	NBR		

O vedador de lábio ou retentor, como é usualmente conhecido, é composto essencialmente de uma membrana elastomérica em forma de “lábio” e uma parte estrutural metálica, que permite a fixação do lábio na posição correta de trabalho na aplicação.

O retentor tem por função primordial reter óleos, graxas ou outros fluidos que devam ser contidos no interior de uma máquina ou um agregado mecânico.

O retentor é sempre aplicado entre duas peças que tenham um movimento relativo, por exemplo: entre um eixo que transmite um movimento e a carcaça de sustentação do mancal deste eixo (figura 1).

Ele cumpre esta função de vedação tanto na condição estática, de máquina parada, como na condição dinâmica, em movimento, e também na variedade de condições de temperatura e meio externo para as quais a máquina está projetada.

A vedação se dá pelo contato permanente que ocorre entre a aresta do lábio de vedação e o eixo da máquina. Para completar a estanqueidade com o meio externo, é preciso que haja também a vedação entre a parte externa estrutural do vedador e a carcaça.

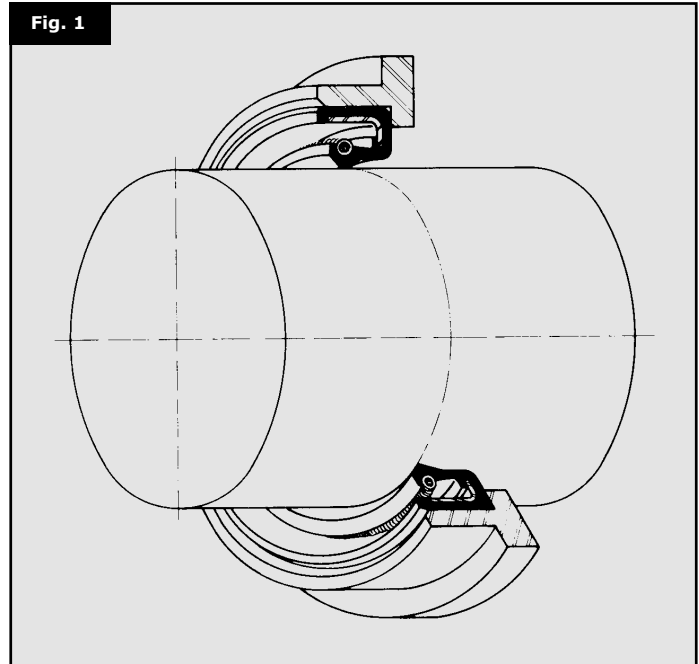

CARACTERÍSTICAS DO LÁBIO DE VEDAÇÃO

Partindo-se do lábio convencional como ilustrado na figura 2, pode-se obter uma maior eficiência de vedação adicionando-se nervuras moldadas ao ângulo de ar, que proporcionam o conhecido efeito hidrodinâmico de vedação.

Este efeito hidrodinâmico promove o refluxo ao óleo que, eventualmente, tenha ultrapassado a aresta de vedação, conferindo assim ao lábio uma maior capacidade de estanqueidade, e ainda, uma maior durabilidade, por garantir uma permanente lubrificação na área de contato sob a aresta de vedação.

Existem várias formas geométricas de nervuras hidrodinâmicas, cuja escolha é determinada pelas condições de aplicação do vedador.

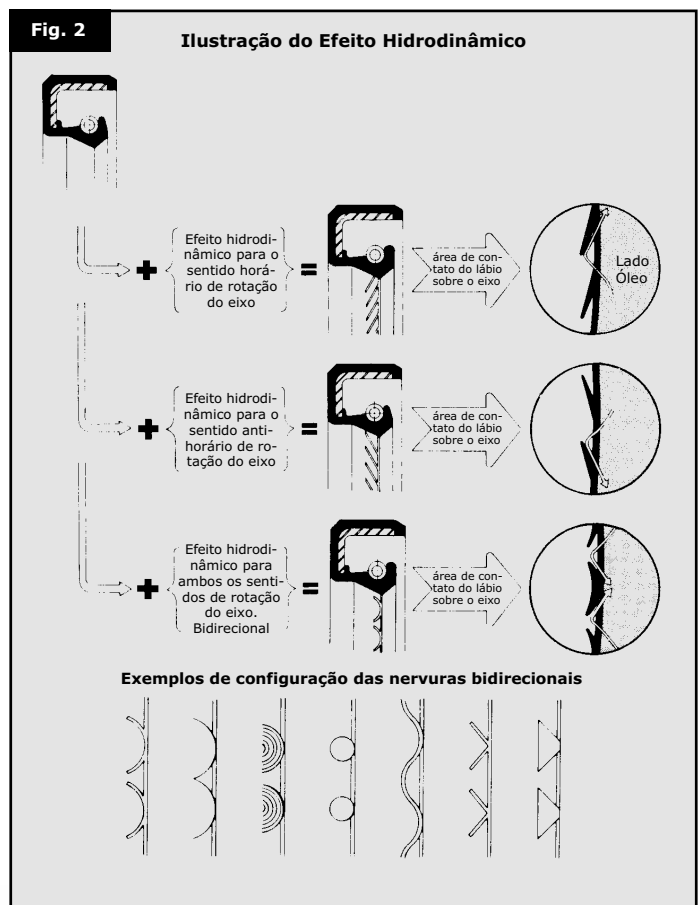

MATERIAIS ELASTOMÉRICOS

Como já citado anteriormente, a vedação se dá por meio da interferência do lábio elastomérico sobre o eixo. Esta condição de trabalho provoca o aparecimento de uma força de atrito na área do lábio com a direção do movimento do eixo e sentido contrário ao mesmo.

A força de atrito e a velocidade periférica do eixo tornam-se responsáveis por uma geração de calor localizada na área de contato do lábio, que tende a promover a degeneração do material e o desgaste do lábio de vedação.

A contenção destes efeitos é conseguida primordialmente pela escolha correta do material elastomérico. É de suma importância que esta escolha seja definida em conjunto com o fabricante do vedador, pois há uma série de fatores de projeto que devem ser igualmente considerados para conferir uma vida prolongada ao vedador.

Na figura 3 estão mostradas as várias qualidades de elastômeros e recomendações genéricas de uso para os diferentes fluidos e limites de temperaturas de trabalho.

Código do elastômero, de acordo com as Normas ISO 1629 e DIN 3761	Tipo de Borracha	Limite de temperatura mínima de trabalho (°C)	Óleos para motor							Álcool + Aditivos	Aplicações Gerais
			Óleo para Caixa de Mudanças	Óleos Hipóides	Óleos p/ Transm. Automática (A.T.F.)	Graxa	Gasolina + Óleo Motor 2T	Óleo para motor			
			Limites de Temperatura máxima de trabalho (°C)								
NBR	Nitrílica	-35	110	110	110	120	90	100	100	Material normalmente utilizado para máquinas e equipamentos industriais. Muito utilizado na indústria automotiva para aplicações gerais.	
ACM	Poliacrílica	-15	130	120	120	130	-	-	-	Material largamente utilizado para motores e transmissões na indústria automobilística.	
MVQ	Silicone	-50	150	-	-	130	-	-	-	Material usualmente empregado em motores de elevado desempenho e em conversores de torque de transmissões automáticas.	
FPM	Fluorelastômetro	-30	150	150	150	150	-	125	125	Material empregado em motores e transmissões, altamente solicitados.	

Fig. 3

Na figura 4 é mostrado um ábaco que indica os limites de velocidade periférica do eixo para cada material, prevendo-se que haja uma boa lubrificação do lábio e também que a pressão interna da máquina seja praticamente igual à pressão externa.

Estas considerações para escolha do material elastomérico devem ser consideradas somente como uma orientação geral. Recomendamos portanto, que para cada nova aplicação de vedador, o projeto seja previamente discutido com a Engenharia de Produtos da Sabó.

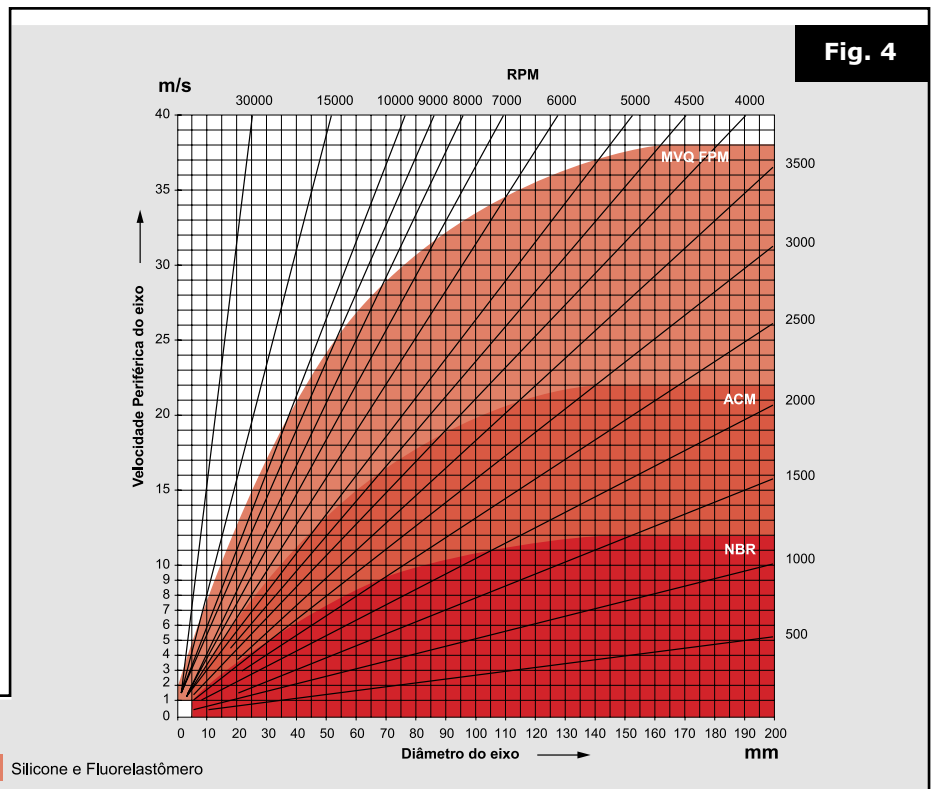

Fig. 4

**Execução do alojamento: (figura 5)**

A seguir estão descritas as recomendações para execução do alojamento, as quais se aplicam todos os tipos de vedadores.

Para o diâmetro do furo do alojamento  $D_F$  deve ser prevista a tolerância ISO H8.

O vedador geralmente é retido no alojamento por interferência entre os diâmetros do alojamento  $D_F$  e o externo do  $D_R$  e sua montagem deve ser executada com auxílio de uma prensa hidráulica. Os valores recomendados para esta interferência, bem como as tolerâncias de  $D_F$  e  $D_R$ , segundo a norma DIN 3761, estão mostrados na figura 6.

O acabamento da superfície do furo poderá ser obtido por usinagem fina com rugosidade de até RT 25u.

Deste modo será garantida uma boa retenção e estanqueidade entre o rentor e o alojamento.

Para se obter uma boa condição de montagem do rentor, deve ser previsto um chanfro de entrada no início do alojamento, com inclinação da ordem de 5° a 15°, numa profundidade de 0,8 mm mínimo. Os cantos desta superfície chanfrada deverão estar livres de rebarbas de usinagem.

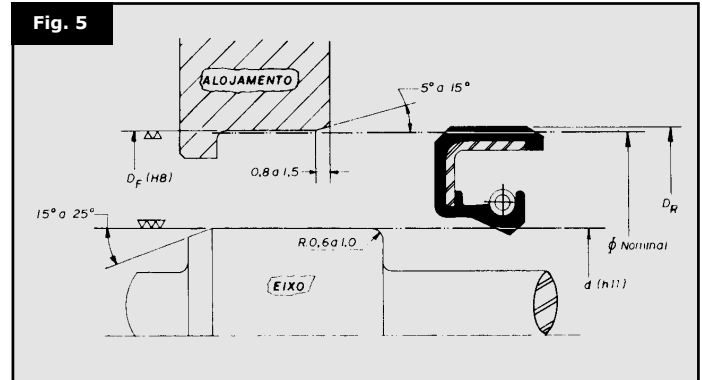

**Execução do eixo de trabalho: (figura 5)**

Para o diâmetro do eixo deverá ser prevista a tolerância, conforme recomendação da norma DIN 3761, ISO h11.

Tolerância de $D_F$ e $D_R$ e interferência resultante					Fig. 6
Dimensões em milímetro					
$\phi$ Nominal	Tol. $D_F$ (H8)	Retentor tipo BR		Retentor tipo BA ou B	
		Tol. $D_R$	Interferência Resultante	Tol. $D_R$	Interferência Resultante
de 10 a 18	0 + 27	+ 0,30 + 0,15	+ 0,300 + 0,123	+ 0,20 + 0,10	+ 0,200 + 0,073
de 18 a 30	0 + 33	+ 0,30 + 0,15	+ 0,300 + 0,117	+ 0,20 + 0,10	+ 0,200 + 0,067
de 30 a 50	0 + 39	+ 0,30 + 0,15	+ 0,300 + 0,111	+ 0,20 + 0,10	+ 0,200 + 0,061
de 50 a 80	0 + 46	+ 0,35 + 0,20	+ 0,350 + 0,154	+ 0,23 + 0,13	+ 0,230 + 0,084
de 80 a 120	0 + 54	+ 0,35 + 0,20	+ 0,350 + 0,146	+ 0,25 + 0,15	+ 0,250 + 0,096
de 120 a 180	0 + 63	+ 0,45 + 0,25	+ 0,450 + 0,187	+ 0,28 + 0,18	+ 0,280 + 0,117
de 180 a 300	0 + 72	+ 0,45 + 0,25	+ 0,450 + 0,178	+ 0,30 + 0,20	+ 0,300 + 0,128

**Exemplos de utilização:**

— Cálculo de  $D_F = \phi + Tol. D_F$  .....Ex.  $D_{F_{\min}} = 65 + 0.000 = 65.000$   
 $D_{F_{\max}} = 65 + 0.046 = 65.046$

— Cálculo de  $D_R = \phi + Tol. D_R$  .....Ex.  $D_{R_{\min}} = 65 + 0.200 = 65.200$   
 $D_{R_{\max}} = 65 + 0.350 = 65.350$

Cálculo da Interferência Resultante:

$Int_{\max} = D_{R_{\max}} - D_{F_{\min}}$  .....Ex.  $65.350 - 65.000 = 0.350 = Int_{\max}$   
 $Int_{\min} = D_{R_{\min}} - D_{F_{\max}}$  .....Ex.  $65.200 - 65.046 = 0.154 = Int_{\min}$

## RECOMENDAÇÕES QUANTO À SUPERFÍCIE DO EIXO

Objetivando conferir uma boa durabilidade e eficiência de trabalho ao retentor, a superfície do eixo onde trabalha o lábio deverá atender as seguintes exigências:

- O acabamento final desta superfície deve ser obtido por operação de retífica de topo com valores de rugosidade RA dentro de 0,2 a 0,5u ou RT de 1,60 a 4,0u. Nesta operação de retífica, deverão ser evitados os movimentos transversais do rebolo, que possam imprimir riscos com orientação helicoidal na superfície do eixo.

- A superfície de trabalho do lábio do retentor deve ser isenta de danificações, tais como: batidas, sulcos, trincas, falhas de material, oxidações ou deformações.

- A dureza do eixo na região de trabalho do retentor deverá estar acima de 215 RC.

Visando uma boa condição de montagem, de modo que o lábio do retentor não sofra danificações ou deformações no ato da instalação, é recomendável que os cantos dos eixos sejam chanfrados com inclinação de 15 a 25° ou arredondados com raio de 0,6 a 1,0mm na região que passa sob o lábio. Os cantos devem ser arredondados e livres de rebarbas.

É importante também que o lábio de vedação durante a instalação do vedador evite contato direto com regiões do eixo contendo rasgos de chaveta, entalhados ou com usinagem grosseira. Caso isto seja inevitável, deve-se prover uma luva protetora com superfície em seu diâmetro externo respeitando as mesmas recomendações sugeridas para o eixo de trabalho.

### Tolerâncias de excentricidade do alojamento:

Devido a inevitáveis variações de usinagem do alojamento e do mancal, é previsto que haja uma certa excentricidade entre os mesmos. Em outras palavras, a linha de centro geométrico do alojamento do retentor não coincide exatamente com a linha de centro efetiva de giro do eixo (figura 7). A distância entre estas duas linhas de centros, assim definida como excentricidade estática, deverá ser mantida dentro dos limites estreitos indicados na figura 8.

### Tolerâncias de excentricidade do eixo:

Igualmente é previsto que na usinagem do eixo haja uma certa excentricidade entre a linha de centro efetiva de giro do eixo e a linha de centro do diâmetro da pista de trabalho do retentor (figura 9). A excentricidade dinâmica, assim definida, também deverá estar contida dentro dos valores recomendados na figura 10.

Para valores muito acima dos recomendados, haverá o risco do lábio de vedação, devido à sua inércia, não conseguir manter o contato com o eixo. Principalmente no caso de elevadas velocidades angulares.

Fig. 7

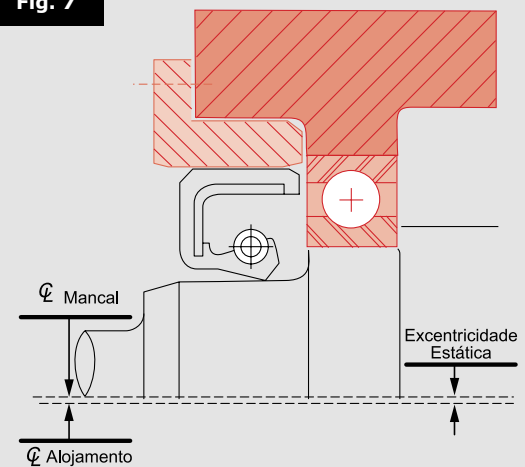

Fig. 8

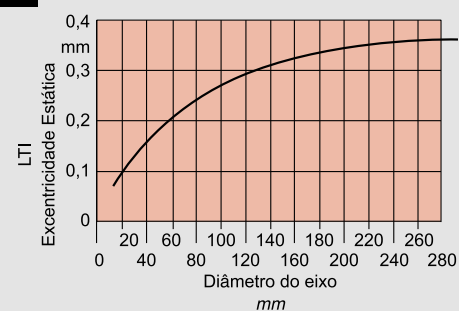

Fig. 9

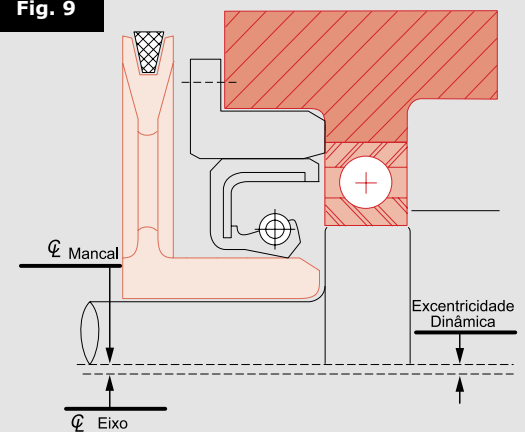
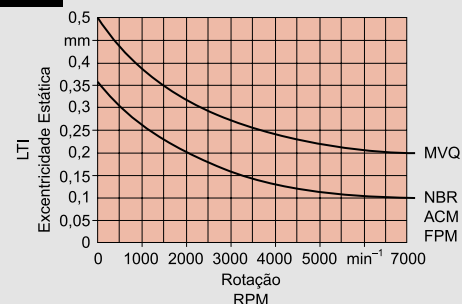

Fig. 10



## RECOMENDAÇÕES QUANTO ÀS CONDIÇÕES DE MONTAGEM

### 1 – Cuidados no armazenamento:

Durante o período de armazenamento, os retentores deverão ser mantidos na própria embalagem Sabó, estocados em local limpo e de forma apropriada, com temperaturas médias recomendadas entre 10° a 40° C, livre de contaminações e manipulações desnecessárias que possam provocar deformações ou danificações.

### 2 – Cuidados na manipulação do retentor:

Ao ser desembalado para a montagem, recomenda-se todo cuidado possível para não tocar desnecessariamente no lábio de vedação, de modo a não introduzir deformações, danificações ou deposição de elementos estranhos na aresta de vedação que possam comprometer o bom desempenho na aplicação.

### 3 – Cuidados na pré-lubrificação do retentor:

Para garantir uma instalação perfeita do retentor no furo do alojamento e também para propiciar a lubrificação inicial da aresta de vedação, por ocasião dos primeiros giros no funcionamento do agregado, recomenda-se pré-lubrificar o lábio do retentor, no próprio fluido da aplicação, mantendo-o em recipiente apropriado e perfeitamente protegido de contaminações externas.

### 4 – Montagem do retentor no alojamento:

A prensagem do retentor na sede deverá ser feita mediante o uso de uma prensa mecânica ou hidráulica, utilizando-se dispositivos apropriados que atendam às seguintes recomendações:

- Deve-se garantir uma perfeita pré-centralização do retentor, de modo que o mesmo seja prensado na posição correta no alojamento.
- A superfície de apoio no dispositivo do retentor deverá estar o mais próximo possível do diâmetro externo do retentor, de modo a evitar deformações no ato da prensagem.
- De forma alguma o dispositivo deve danificar o lábio de vedação.

Na figura 11 estão ilustrados alguns tipos de dispositivos usualmente empregados.

### 5 – Montagem do retentor no eixo de trabalho:

Não havendo possibilidade de chanfrar ou arredondar as superfícies do eixo sobre as quais deve ser introduzido o retentor, ou então, no caso do retentor ter que passar obrigatoriamente por uma região irregular, como entalhados ou rasgos de chaveta, recomenda-se o uso de uma luva de proteção para o lábio, conforme ilustrado na figura 12, observando que o diâmetro da luva não deforme o lábio.

É de extrema importância que estas luvas estejam com as superfícies externas, por onde passa o lábio do retentor, bem polidas, perfeitamente limpas e livres de danificações ou arestas vivas, provocadas por batidas durante o seu manuseio constante.

### 6 – Cuidados na substituição do retentor:

Em princípio, sempre que houver a desmontagem de um agregado, por qualquer motivo que implique na desmontagem do retentor ou do eixo de trabalho após o uso, recomenda-se a reposição do retentor por um novo.

Quando a substituição do eixo não for possível, a aresta de vedação do novo retentor não deverá trabalhar na mesma pista deixada pelo retentor anterior. Sempre dever-se-á montá-lo deslocado para o lado interior, observando-se que o eixo esteja em perfeitas condições, livres de defeitos, deposições sólidas ou oxidação. Não lixar a superfície do eixo.

Muitas vezes, devido ao estado da superfície do furo do alojamento, é inevitável o uso de massa de vedação no externo do retentor para garantir a estanqueidade através do furo do alojamento.

Nestes casos deve-se tomar cuidado para que essa massa de vedação não atinja o lábio de vedação ou o eixo de trabalho, pois, em tais casos, poderá impedir o bom desempenho do retentor e acarretar vazamento.

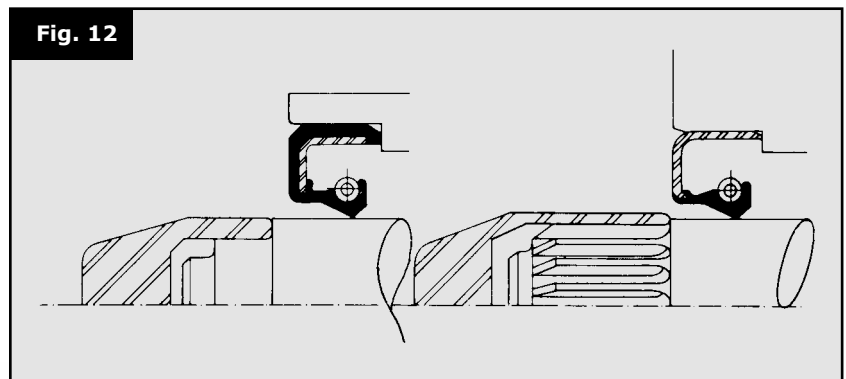
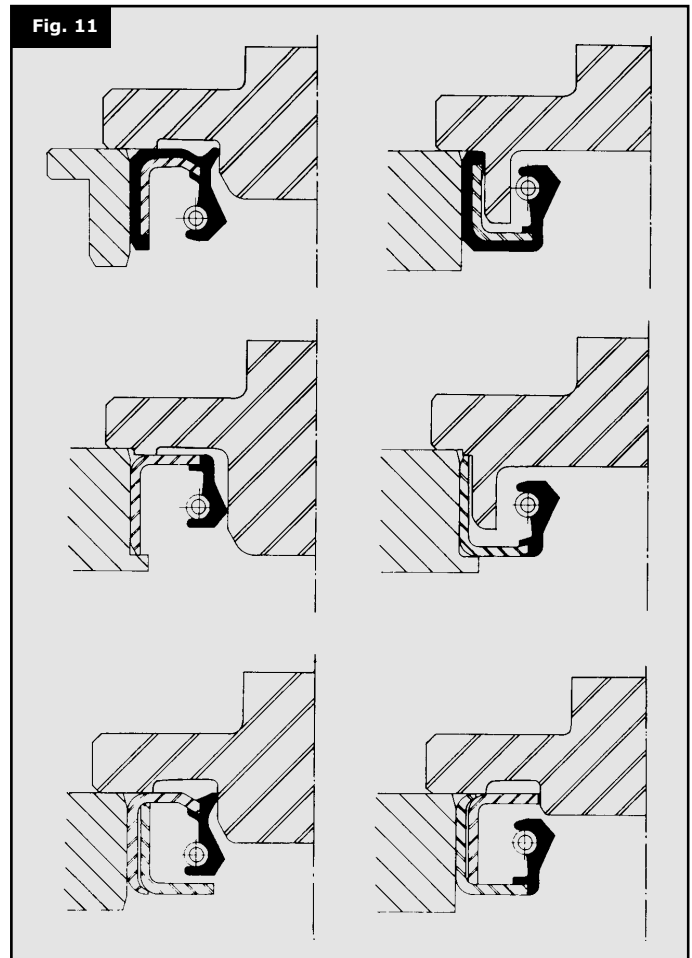

# NORMATIZAÇÃO DE MEDIDAS DOS RETENTORES SEGUNDO A NORMA DIN 3761

Na figura 13 estão indicadas as medidas do diâmetro do eixo, diâmetro nominal do alojamento e altura dos retentores recomendados pela Norma DIN 3761.

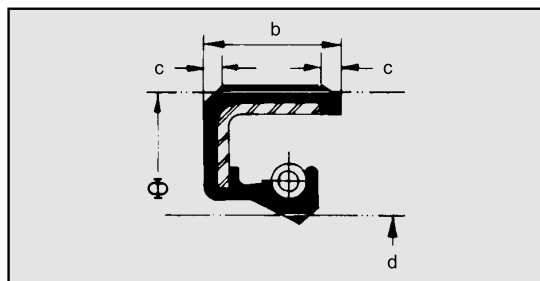

**Fig. 13**

Diametro do eixo d	Φ	b	c min.
6	16	7	0.3
	22		
7	22	7	0.3
	24		
8	22	7	0.3
	24		
9	22	7	0.3
	24		
	26		
10	22	7	0.3
	24		
	26		
11	22	7	0.3
	26		
	28		
12	22	7	0.3
	24		
	28		
	30		
14	24	7	0.3
	28		
	30		
	35		
15	26	7	0.3
	30		
	32		
16	28	7	0.3
	30		
	32		
	35		
17	28	7	0.3
	30		
	32		
	35		
18	40	7	0.3
	30		
	32		
	35		
20	40	7	0.3
	30		
	32		
	35		
22	40	7	0.3
	32		
	35		
	40		
24	40	7	0.3
	32		
	35		
	40		
25	40	7	0.3
	35		
	42		
	47		
26	40	7	0.3
	37		
	42		
	47		
28	40	7	0.4
	47		
	52		
	52		

Diametro do eixo d	Φ	b	c min.
30	40	7	0.4
	42		
	47		
	52		
32	45	7	0.4
	47		
	52		
	52		
35	47	7	0.4
	50		
	52		
	62		
36	47	7	0.4
	50		
	52		
	62		
38	52	7	0.4
	55		
	62		
	62		
40	52	7	0.4
	55		
	62		
	72		
42	55	8	0.4
	62		
	72		
	72		
45	60	8	0.4
	62		
	65		
	72		
48	62	8	0.4
	72		
	65		
	68		
50	72	8	0.4
	80		
	72		
	80		
52	68	8	0.4
	72		
	70		
	72		
55	72	8	0.4
	80		
	85		
	70		
56	72	8	0.4
	80		
	85		
	85		
58	72	8	0.4
	80		
	75		
	80		
60	85	8	0.4
	85		
	90		
	90		
62	85	10	0.5
	90		
	85		
	90		
63	85	10	0.5
	90		
	85		
	90		
65	90	10	0.5
	100		
	90		
	100		
68	90	10	0.5
	100		

Diametro do eixo d	Φ	b	c min.
70	90	10	0.5
	100		
72	95	10	0.5
	100		
75	95	10	0.5
	100		
78	100	10	0.5
	100		
80	100	10	0.5
	110		
85	110	12	0.8
	120		
90	110	12	0.8
	120		
95	120	12	0.8
	125		
100	120	12	0.8
	125		
105	130	12	0.8
	140		
110	130	12	0.8
	140		
115	140	12	0.8
	150		
120	150	12	0.8
	160		
125	150	12	0.8
	160		
130	160	12	0.8
	170		
135	170	12	0.8
	170		
140	170	15	1
	175		
145	175	15	1
	180		
150	180	15	1
	190		
160	190	15	1
	200		
170	200	15	1
	210		
180	210	15	1
	220		
190	220	15	1
	230		
200	230	15	1
	240		
210	240	15	1
	250		
220	250	15	1
	260		
230	260	15	1
	270		
240	270	15	1
	280		
250	280	15	1
	300		
260	300	20	1
	320		
280	320	20	1
	340		
300	340	20	1
	360		
320	360	20	1
	380		
340	380	20	1
	400		
360	400	20	1
	420		
380	420	20	1
	440		
400	440	20	1
	460		
420	460	20	1
	480		
440	480	20	1
	500		
460	500	20	1
	520		
480	520	20	1
	540		

1) Tolerâncias permissíveis para Φ, vide fig. 6

### 1. Membrana elastomérica (ou lábio)

- 1.a. Ângulo de ar
- 1.b. Aresta de vedação
- 1.c. Ângulo de óleo
- 1.d. Região de cobertura da mola
- 1.e. Alojamento de mola
- 1.f. Região interna do lábio
- 1.g. Região de engaste do lábio

### 2. Mola de tração

### 3. Região interna do vedador, eventualmente recoberta por material elastomérico.

### 4. Anel de reforço metálico ou carcaça.

- 4.a. Porção cilíndrica de sustentação
- 4.b. Flange radial de engaste

### 5. Cobertura externa elastomérica

- 5.a. Borda
- 5.b. Chanfro da borda
- 5.c. Superfície cilíndrica externa ou diâmetro externo
- 5.d. Chanfro das costas
- 5.e. Costas

### 6. Filetes de escoamento de moldagem



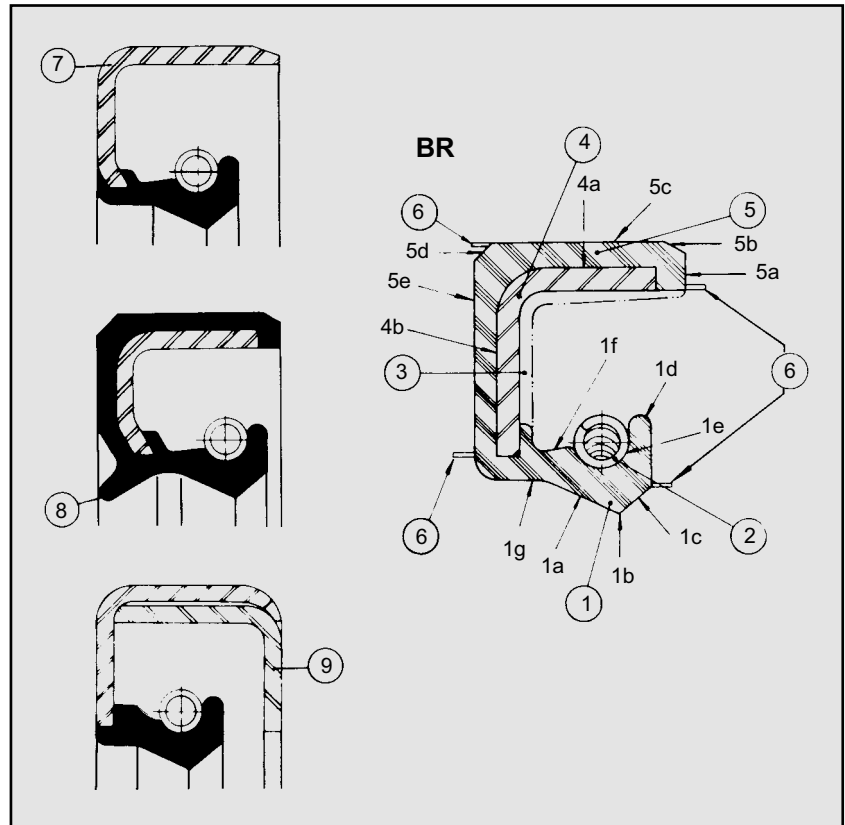

### 7. Carcaça externa metálica

### 8. Vedação auxiliar

### 9. Carcaça interna metálica

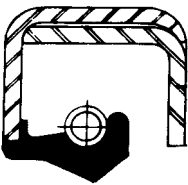

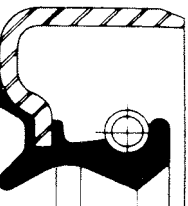
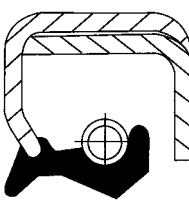
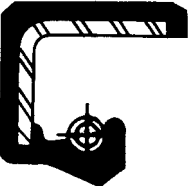
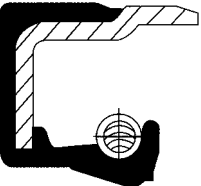

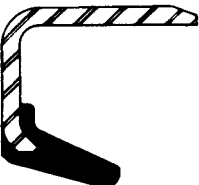
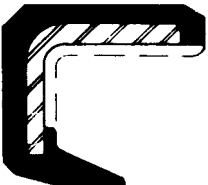
<p><b>B</b></p> 	<p><b>BA</b></p> 	<p><b>BAG</b></p> 	<p><b>BG</b></p> 
<p><b>BR</b></p> 	<p><b>BRA</b></p> 	<p><b>BRG</b></p> 	<p><b>BRAG</b></p> 
<p><b>GA</b></p> 	<p><b>GR</b></p> 	<p><b>ESTRIAS DO LÁBIO (ORIENTAÇÃO)</b></p> <ul style="list-style-type: none"> <li>L = Liso</li> <li>H = Horário</li> <li>AH = Anti-horário</li> <li>BI = Bidirecional</li> <li>RE = Rosca Esquerda</li> </ul>	<p><b>MATERIAL DO LÁBIO</b></p> <ul style="list-style-type: none"> <li>NBR = nitrílica</li> <li>ACM = poliacrílica</li> <li>MVQ = silicone</li> <li>FPM = flúor</li> </ul>

**LEGENDAS**

**BR** - Vedação principal de borracha com mola, recoberto externamente com borracha.

**BRG** - Vedação principal de borracha com mola, proteção contra poeira, recoberto externamente com borracha.

**BA** - Vedação principal de borracha com mola e diâmetro externo de metal.

**BAG** - Vedação principal de borracha com mola, proteção contra poeira e diâmetro externo de metal.

**B** - Vedação principal de borracha com mola, diâmetro externo de metal, com tampa.

**BG** - Vedação principal de borracha com mola, diâmetro externo de metal, proteção contra poeira, recoberto com borracha e tampa.

**GR** - Vedação principal de borracha, sem mola e diâmetro externo recoberto com borracha.

**GA** - Vedação principal de borracha, sem mola e diâmetro externo de metal.

## TIPOS BÁSICOS

Diâmetro Eixo	Diâmetro Alojamento	Altura Retentor	Tipo	Orientação	Material Lábio	Nº SABO	Página
6,0	10,0	2,5	GR	LI	NBR	02515GR	20
6,4	19,1	6,4	BR	LI	NBR	01685BR	20
6,5	14,5	7,0	BRG	LI	NBR	02306BRG	20
8,0	14,0	3,0	BR	LI	FPM	02495BRF	20
8,0	14,0	3,0	BR	LI	NBR	02536BR	20
8,0	14,0	4,0	BRA	LI	FPM	07465BRAAF	20
8,0	15,0	3,0	GR	LI	NBR	02491GR	20
8,0	16,0	7,0	BA	H	ACM	02013BAP	20
8,0	18,0	5,0	BR	LI	NBR	01423BR	20
8,0	18,0	5,0	BRG	LI	NBR	02163BRG	20
8,0	22,0	8,0	BR	LI	NBR	01587BR	20
8,5	16,0	6,5	BR	H	NBR	00998BR	20
9,5	19,2	7,0	BR	LI	NBR	01093BR	20
10,0	15,0	3	GA	LI	NBR	03267GA	20
10,0	19,0	6,5	BR	LI	NBR	02171BR	20
10,0	22,0	7,0	BR	LI	NBR	01672BR	20
10,0	30,0	7,0	BA	LI	NBR	00764BA	20
11,0	17,0	4,0	BR	LI	NBR	01737BR	20
11,0	17,0	4,0	BR	LI	FPM	01737BRF	20
11,0	17,0	4,0	BR	LI	FPM	02523BRF	20
11,1	25,4	6,0	BR	LI	NBR	01479BR	20
11,6	24,0	10,0	BRG	LI	ACM	07408BRGP	20
11,9	24,0	6,0	BRG	H	FPM	05548BRGF	20
12,0	18,0	3,0	GR	LI	NBR	02638GR	20
12,0	20,0	5,0	BAG	LI	NBR	02689BAG	20
12,0	21,0	4/00	BR	LI	NBR	03255BR	20
12,0	22,0	5,0	BRG	LI	NBR	02535BRG	20
12,0	22,0	7,0	BA	LI	NBR	00289BA	20
12,0	28,1	8,0	BAG	LI	NBR	02792BAG	20
12,0	28,1	7,0	BR	LI	NBR	01420BR	20
12,4	19,0	5,0	BR	BI	FPM	05148BRF	20
12,5	20,0	5,0	BR	BI	FPM	02360BRF	20
12,7	22,2	8,0	BR	LI	NBR	01559BR	20
12,7	25,4	6,4	GA	LI	NBR	00981GA	20
12,7	25,4	6,4	BA	BI	NBR	01966BA	20
12,7	25,4	9,5	BR	LI	NBR	00129BR	20
12,7	30,0	8,0	BR	LI	NBR	01097BR	20
13,0	26,0	7,0	BRG	LI	NBR	02373BRG	20
13,0	26,0	9,0	BRG	LI	NBR	01074BRG	20
13,8	24,0	5,0	BRG	LI	NBR	03389BRG	20
14,0	20,0	3,5	BA	LI	NBR	02025BA	20
14,0	22,0	4,0	BRG	LI	ACM	02569BRGP	20
14,0	22,0	5,0	BRG	BI	NBR	03252BR	20
14,0	24,0	6,0	BRG	LI	NBR	02162BRG	20
14,0	24,0	7,0	BAG	LI	NBR	01389BAG	20
14,0	28,0	7,0	BRG	LI	NBR	02308BRG	20
14,0	32,0	10,0	BR	LI	NBR	01875BR	20

Diâmetro Eixo	Diâmetro Alojamento	Altura Retentor	Tipo	Orientação	Material Lábio	Nº SABO	Página
14,3	24,0	7,0	BR	LI	NBR	01835BR	20
14,3	28,5	6,4	BR	LI	NBR	00293BR	20
15,0	21,0	3,0	GR	LI	NBR	02589GR	20
15,0	21,0	4,0	BAG	LI	NBR	02130BAG	20
15,0	23,0	3,0	GR	LI	NBR	02639GR	20
15,0	24,0	7,0	BR	LI	NBR	00790BR	20
15,0	24,0	7,0	BAG	LI	NBR	01929BAG	20
15,0	24,0	7,0	BRG	LI	HNBR	01929BRG	20
15,0	24,0	7,4	BA	AH	NBR	01816BA	20
15,0	25,0	7,0	BR	AH	ACM	02309BRP	20
15,0	25,0	7,0	BRG	LI	NBR	02454BRG	20
15,0	26,0	6,0	BAG	LI	NBR	02279BAG	20
15,0	26,0	7,0	BRG	LI	NBR	07518BRG	20
15,0	28,0	7,0	BA	LI	NBR	00916BA	20
15,0	30,0	5,0	GA	LI	NBR	00515GA	20
15,0	30,0	7,0	BR	LI	NBR	01677BR	20
15,0	30,0	7,0	BAG	LI	NBR	01846BAG	20
15,0	30,0	10,0	BR	LI	NBR	01348BR	20
15,0	32,0	7,0	BR	LI	NBR	01907BR	20
15,0	35,0	7,0	BR	LI	NBR	01058BR	20
15,0	35,0	7,0	BAG	LI	NBR	01959BAG	20
15,9	22,2	4,3	BAG	LI	NBR	02335BAG	20
15,9	25,4	6,4	BA	LI	NBR	01175BA	20
15,9	25,4	4,5	BR	LI	NBR	00286BR	20
15,9	28,5	7,0	BR	LI	NBR	01493BR	20
15,9	28,6	9,5	B	LI	NBR	00156B	20
15,9	30,0	6,0	BAG	H	NBR	01934BAG	20
15,9	35,0	10,0	BA	LI	NBR	00375BA	20
16,0	22,0	3,0	GR	LI	NBR	02492GR	20
16,0	22,1	6,4	BAG	LI	NBR	01576BAG	20
16,0	22,8	4,8	BR	LI	NBR	07519BR	20
16,0	28,0	7,0	BA	LI	NBR	00980BA	20
16,0	28,0	7,0	BRG	LI	NBR	02310BRG	20
16,0	30,0	6,4	BA	AH	NBR	01817BA	20
16,0	30,0	10,0	BR	LI	NBR	00795BR	20
16,0	32,0	7,0	BR	LI	NBR	00796BR	20
16,3	24,0	7,0	BR	LI	NBR	00726BR	20
17,0	25,0	3,0	GR	LI	NBR	02640GR	20
17,0	25,0	4,0	BR	LI	NBR	02161BR	20
17,0	25,0	4,0	BRG	LI	NBR	02571BRG	20
17,0	25,0	4,0	GA	LI	NBR	02669GA	20
17,0	27,0	5,0	BRG	LI	NBR	03253BRG	20
17,0	28,0	5,0	BRG	LI	NBR	02701BRG	20
17,0	28,0	6,0	BR	LI	NBR	01072BR	20
17,0	28,0	7,0	BA	LI	NBR	00508BA	20
17,0	28,0	7,0	BA	LI	NBR	00508BAG	20
17,0	28,0	7,0	BA	H	NBR	03477BA	20

Diámetro Eixo	Diámetro Alojamento	Altura Retentor	Tipo	Orien-tación	Material Lábío	N° SABO	Página
17,0	28,0	7,0	BRA	LI	NBR	05141BRA	20
17,0	28,1	5,0	BR	LI	NBR	02375BR	20
17,0	29,0	5,4	BR	AH	ACM	07409BRP	20
17,0	30,0	7,0	BRG	LI	NBR	02730BRG	20
17,0	32,0	7,0	BR	LI	NBR	01725BR	20
17,0	32,0	7,0	BR	LI	NBR	02425BR	20
17,0	35,0	7,0	BR	LI	NBR	00853BR	20
17,0	35,0	8,0	BR	LI	NBR	01511BR	20
17,0	35,1	7,0	BRG	LI	NBR	01113BRG	20
17,0	40,0	8,5	B	LI	NBR	01492BR	20
18,0	30,0	7,0	BRG	LI	NBR	00496BRG	20
18,0	30,0	6,4	BRG	LI	ACM	07328BRGP	20
18,0	35,0	10,0	BR	LI	NBR	01769BR	20
18,0	37,0	8,0	BRG	LI	NBR	02164BRG	20
18,0	40,0	9,0	BR	LI	NBR	01107BR	20
18,0	47,0	8,0	BR	LI	NBR	01400BR	20
18,8	31,7	11,0	BAG	LI	NBR	02203BAG	20
18,9	30,0	5,3	BRG	AH	ACM	05586BRGP	20
19,0	25,4	4,3	GR	LI	ACM	07888GRP	20
19,0	28,5	6,4	BA	LI	NBR	00329BA	20
19,0	28,6	6,5	BAG	LI	NBR	02131BAG	20
19,0	29,1	6,4	BR	LI	NBR	01909BR	20
19,0	31,7	6,4	B	LI	NBR	00569B	20
19,0	31,7	6,4	BR	LI	NBR	00569BR	20
19,0	31,8	8,0	BAG	LI	NBR	00989BAG	20
19,0	31,8	6,4	BR	LI	NBR	00821BR	20
19,0	31,9	7,0	BA	LI	NBR	00798BA	20
19,0	35,0	10,3	BA	BI	ACM	01965BAP	20
19,0	35,0	7,0	BR	LI	NBR	00784BR1	20
19,0	35,0	10,0	BR	LI	NBR	00159BR	20
19,3	29,1	6,4	BR	LI	NBR	01110BR	20
19,9	35,0	7,0	BRG	LI	NBR	01894BRG	20
20,0	26,0	4,0	GR	LI	NBR	02573GR	20
20,0	28,0	4,0	GR	LI	NBR	02641GR	20
20,0	30,0	7,0	BR	LI	NBR	00505BR	20
20,0	30,0	7,0	BAG	LI	NBR	01935BAG	20
20,0	31,0	7,0	BA	LI	NBR	03013BA	20
20,0	31,0	7,0	BRA	LI	NBR	05142BRA	20
20,0	31,0	7,0	BRA	LI	NBR	05142BRAf	20
20,0	32,0	6,0	BR	LI	NBR	00712BR	20
20,0	32,1	7,0	BR	LI	NBR	00953BR	20
20,0	34,0	7,0	BR	AH	NBR	02311BR	20
20,0	35,0	6,0	BA	LI	NBR	00715BA	20
20,0	35,0	6,0	BRG	LI	NBR	02821BRG	20
20,0	35,0	7,0	BR	LI	NBR	02486BR	20
20,0	35,0	8,0	BRG	LI	NBR	01386BRG	20
20,0	35,0	10,0	BR	LI	NBR	00760BR	20
20,0	35,1	4,0	BR	LI	NBR	01404BR	20
20,0	38,0	6,0	BRG	AH	NBR	03004BRG	20

Diámetro Eixo	Diámetro Alojamento	Altura Retentor	Tipo	Orien-tación	Material Lábío	N° SABO	Página
20,0	38,1	6,4	BA	LI	ACM	02072BAP	20
20,0	39,7	6,5	BRG	LI	NBR	02433BRG	20
20,0	40,0	6,0	BR	LI	NBR	02045BR	20
20,0	40,0	7,0	BA	LI	NBR	00994BA	20
20,0	40,0	7,0	BRG	LI	NBR	00994BRG	20
20,0	40,0	7,0	BRG	LI	NBR	02468BRG	20
20,0	40,0	7,0	BRG	LI	FPM	02566BRGF	20
20,0	40,0	10,0	BA	LI	NBR	00360BA	20
20,0	42,0	10,0	B	LI	NBR	01746B	20
20,0	47,1	10,0	BR	LI	NBR	00909BR	20
20,6	38,1	7,0	BAG	LI	ACM	02480BAGP	20
21,0	32,0	7,0	BR	LI	NBR	01985BR	20
21,0	32,0	7,0	BAG	LI	NBR	01883BAG	20
21,0	32,0	7,5	BAG	H	NBR	02371BAG	20
21,5	40,0	7,0	BR	H	ACM	02418BRP	20
21,5	40,0	7,0	BR	H	ACM	07286BRP	20
21,8	25,0	1,9	GA	LI	NBR	02073GA	20
21,8	35,0	7,0	BRG	H	ACM	02740BRGP	20
21,9	40,0	8,0	BRG	H	ACM	07458BRGP	20
22,0	31,9	5,0	BA	LI	NBR	00769BA	20
22,0	32,0	5,5	BR	LI	NBR	01727BR	20
22,0	32,0	7,0	BRG	LI	NBR	01554BRG	20
22,0	35,0	6,7	BR	LI	NBR	00294BR	20
22,0	35,0	7,0	BR	LI	NBR	01716BR	20
22,0	35,0	7,0	BRG	LI	NBR	02572BRG	20
22,0	35,0	7,0	BRG	LI	NBR	02579BRG	20
22,0	35,0	9,0	BAG	LI	NBR	00955BAG	20
22,0	35,0	10,0	BAG	LI	NBR	00118BAG	20
22,0	35,0	7	BRG	AH	ACM	02533BRGP	20
22,0	38,1	8,0	BR	LI	NBR	01120BR	20
22,0	40,0	7,0	BR	LI	NBR	00761BR	20
22,0	40,0	8,0	BRG	LI	NBR	00992BRG	20
22,0	40,0	8,0	B	H	ACM	02009BP	20
22,0	41,3	8,0	BA	AH	NBR	01481BA	20
22,0	42,0	10,0	BR	LI	NBR	00815BR	20
22,0	47,0	9,0	B	LI	NBR	01779B	20
22,2	34,9	8,0	BAG	LI	NBR	00937BAG	20
22,2	35,0	8,0	B	LI	NBR	00937B	20
22,2	50,8	11,1	BAG	LI	NBR	02064BAG	20
22,3	35,0	6,4	BR	LI	NBR	00572BR	20
22,8	40,0	8,0	BRAG	H	ACM	07309BRAGP	20
23,0	35,0	8,0	BAG	H	NBR	02372BAG	20
23,0	35,0	8,0	BAG	H	FPM	02837BAGF	20
24,0	35,0	6,0	BR	H	FPM	02594BRF	20
24,0	36,0	6,0	BR	LI	NBR	01666BR	20
24,0	37,0	7,0	BR	LI	NBR	02014BR	20
24,0	37,0	7,0	BRG	LI	NBR	02210BRG	20
24,0	38,0	6,0	BR	H	ACM	07451BRP	20
24,0	38,0	9,0	BR	LI	NBR	00829BR	20

## TIPOS BÁSICOS

Diâmetro Eixo	Diâmetro Alojamento	Altura Retentor	Tipo	Orien-tação	Material Lábio	Nº SABÓ	Página	Diâmetro Eixo	Diâmetro Alojamento	Altura Retentor	Tipo	Orien-tação	Material Lábio	Nº SABÓ	Página
24,0	40,1	10,0	BR	LI	NBR	01341BR	20	26,0	35,0	7,0	BRG	LI	NBR	02568BRG	20
24,0	42,0	10,0	BR	LI	NBR	01507BR	20	26,0	37,0	7,0	BRG	LI	NBR	01045BRG	20
24,0	47,0	7,0	BR	LI	NBR	00763BR	20	26,0	40,0	8,0	BRG	H	NBR	02412BRG	20
24,6	39,9	8,0	BAG	LI	NBR	01712BAG	20	26,0	42,0	8,0	BRAG	H	FPM	02525BRAGF	20
25,0	32,0	4,0	GA	LI	NBR	02265GA	20	26,0	42,0	10,0	BRG	LI	NBR	01151BRG	20
25,0	32,0	4,0	GR	LI	NBR	02588GR	20	26,0	45,0	10,0	BA	LI	NBR	01860BA	20
25,0	32,0	4,0	GR	LI	NBR	02642GR	20	27,0	37,0	7,0	BRAG	H	FPM	05266BRAGF	20
25,0	32,0	5,0	GA	LI	NBR	07967GA	20	27,0	38,1	6,4	BA	LI	NBR	00285BA	20
25,0	35,0	5,0	GA	LI	NBR	01405GA	20	27,0	38,1	6,4	BR	AH	NBR	01993BR	20
25,0	35,0	5,0	GA	LI	NBR	02107GA	20	27,0	40,0	7,0	BRG	LI	NBR	01751BRG	20
25,0	35,0	7,0	BA	LI	NBR	01543BA	20	27,0	42,0	8,1	BRAG	H	FPM	05269BRAGF	20
25,0	35,0	7,0	BR	LI	NBR	01543BR	20	27,0	42,0	10,0	BR	LI	NBR	01625BR	20
25,0	35,0	7,5	BAG	BI	ACM	02007BAGP	20	27,0	42,9	7,1	BA	LI	NBR	00121BA	20
25,0	35,0	8,0	BRG	H	NBR	02414BRG	20	28,0	34,9	5,0	GA	LI	NBR	00713GA	20
25,0	35,0	10,0	BAG	LI	NBR	00788BAG	20	28,0	38,0	6,5	GR	LI	NBR	01886GR	20
25,0	35,0	6	BRG	H	FPM	03025BRGF	20	28,0	40,0	7,0	BR	LI	NBR	01495BR	20
25,0	36,0	7,0	BR	LI	NBR	01515BR	20	28,0	40,0	7,0	BR	LI	FPM	01495BRF	20
25,0	37,1	7,3	BR	LI	NBR	01577BR	20	28,0	40,0	7,0	BR	LI	MVQ	01495BRS	20
25,0	37,9	7,0	BRG	LI	NBR	01892BRG	20	28,0	40,0	8,0	BRG	H	NBR	02413BRG	20
25,0	38,0	6,4	BR	LI	NBR	01019BR	20	28,0	40,0	8,0	BRG	LI	NBR	02519BRG	20
25,0	40,0	5,0	GR	LI	NBR	01295GR	20	28,0	42,0	7,0	B	LI	NBR	01580B	20
25,0	40,0	7,0	BA	LI	NBR	02062BA	20	28,0	42,0	7,0	BRG	LI	NBR	02145BRG	20
25,0	40,0	7,0	BRG	LI	FPM	02570BRGF	20	28,0	42,0	7,0	BRG	H	NBR	05795BRG	20
25,0	40,0	8,0	BR	LI	NBR	01556BR	20	28,0	42,0	7,0	BRG	H	ACM	05780BRGP	20
25,0	40,0	8,0	BRG	BI	NBR	02233BRG	20	28,0	47,0	8,0	BRG	H	ACM	05780BRGP	20
25,0	40,0	9,0	BRG	LI	NBR	02148BRG	20	28,0	47,0	10,0	B	LI	NBR	00262B	20
25,0	40,0	10,0	B	LI	NBR	00469B	20	28,0	47,0	10,0	BA	LI	NBR	00262BA	20
25,0	41,1	9,5	BR	LI	NBR	00191BR	20	28,0	47,5	9,5	BR	LI	NBR	00947BR	20
25,0	42,0	6,0	BR	LI	NBR	01604BR	20	28,0	52,1	10	BR	LI	NBR	00503BR	20
25,0	42,0	8,0	BA	LI	NBR	00925BA	20	28,4	45,0	8,5	BR	LI	NBR	01188BR	20
25,0	42,0	8,0	BRG	H	MVQ	05516BRGS	20	28,5	50,7	10,0	BA	LI	NBR	00771BA	20
25,0	43,1	10,0	BR	LI	NBR	00506BR	20	28,6	38,0	7,0	BR	LI	NBR	01022BR	20
25,0	44,9	5,0	BR	LI	NBR	00709BR	20	28,6	38,0	7,0	BR	LI	NBR	01299BR	20
25,0	47,0	7,0	BAG	LI	NBR	02010BAG	20	28,6	38,1	6,5	BA	H	NBR	01964BA	20
25,0	47,0	10,0	BR	LI	NBR	00266BR	20	28,6	39,7	9,5	BR	LI	NBR	00054BR	20
25,0	47,0	10,0	BRG	LI	NBR	02046BRG	20	28,6	39,8	4,7	GR	LI	NBR	00117GR	20
25,0	50,1	10,0	BR	LI	NBR	00499BR	20	28,6	39,8	6,4	BR	LI	NBR	01998BR	20
25,0	52,0	8,0	BRG	LI	NBR	02727BRG	20	28,6	39,8	7,0	BR	LI	NBR	00932BR	20
25,0	52,0	10,0	BR	LI	NBR	00463BR	20	28,6	41,3	6,5	BAG	H	NBR	02877BAG	20
25,0	62,0	10,0	B	LI	NBR	00770B	20	28,6	41,3	9,4	BA	AH	NBR	01962BA	20
25,4	35,0	6,4	BA	H	NBR	02032BA	20	28,6	43,0	9,5	BAG	LI	NBR	01661BAG	20
25,4	36,4	6,4	BR	LI	NBR	00283BR	20	28,6	44,5	11,0	BAG	LI	NBR	00634BAG	20
25,4	38,0	9,5	BAG	LI	NBR	01327BAG	20	28,6	50,3	9,5	B	LI	NBR	00950B	20
25,4	38,1	10,0	BA	LI	NBR	00141BA	20	28,6	52,3	9,5	B	LI	NBR	00961B	20
25,4	41,3	9,5	B	LI	NBR	00934B	20	28,6	57,2	9,5	BR	LI	NBR	01635BR	20
25,4	44,6	6,4	BR	LI	NBR	01009BR	20	29,0	50,0	10,0	B	AH	NBR	02244B	20
25,4	46,6	9,5	B	LI	NBR	00145B	20	29,4	42,8	8,0	BRG	LI	NBR	02153BRG	20
25,4	47,6	11,1	B	LI	NBR	01302B	20	29,9	42,0	7,0	BRAG	H	FPM	02681BRAGF	20
25,4	50,7	10,2	BA	LI	NBR	01393BA	20	29,9	45,0	7,0	BA	H	NBR	01833BA	20
								29,9	52,0	8,0	BRG	LI	NBR	01895BRG	20

Diámetro Eixo	Diámetro Alojamento	Altura Retentor	Tipo	Orien-tación	Material Lábío	Nº SABO	Página
30,0	37,0	4,0	GR	LI	NBR	02643GR	20
30,0	37,1	4,0	BA	LI	NBR	02096BA	20
30,0	40,0	7,0	BR	LI	NBR	01535BR	20
30,0	40,0	7,0	BR	H	ACM	01903BRP	20
30,0	40,0	7,0	BRG	H	MVQ	05531BRGS	20
30,0	40,0	8,0	BA	LI	NBR	00810BA	20
30,0	42,0	6,0	BRG	BI	NBR	05117BRG	20
30,0	42,0	7,0	BAG	LI	NBR	00847BAG	20
30,0	42,0	7,0	BRAG	H	FPM	05093BRAGF	20
30,0	42,0	8,0	BR	H	MVQ	05507BRS	20
30,0	42,0	10,0	BRG	LI	NBR	02234BRG	20
30,0	42,0	7	BRG	H	ACM	02539BRGP	20
30,0	42,1	8,0	BR	LI	NBR	01667BR	20
30,0	43,0	9,5	BA	LI	NBR	00813BA	20
30,0	43,0	9,5	BAG	LI	NBR	00813BAG	20
30,0	43,0	8,0	BRAG	H	FPM	05074BRAGF	20
30,0	44,0	7,0	BRG	H	ACM	05530BRGP	20
30,0	45,0	12,0	BR	LI	NBR	00832BR	20
30,0	46,4	10,0	BA	LI	NBR	01831BA	20
30,0	47,0	6,0	BR	LI	NBR	01695BR	20
30,0	47,0	6,0	BR	AH	NBR	02593BR	20
30,0	47,0	7,0	BRG	AH	NBR	02376BRG	20
30,0	47,0	7,0	BRG	H	MVQ	02678BRGS	20
30,0	47,0	7,0	BRAG	H	ACM	05202BRAGP	20
30,0	47,0	10,0	BR	LI	NBR	00131BR	20
30,0	47,0	10,0	BRG	BI	ACM	02930BRGP	20
30,0	50,0	7,0	BRAG	H	FPM	02817BRAGF	20
30,0	50,0	10,0	BR	LI	NBR	00358BR	20
30,0	50,0	11,0	BRG	LI	NBR	00911BRG	20
30,0	50,1	12,0	BA	LI	NBR	00484BA	20
30,0	50,8	11,0	B	LI	NBR	00701B	20
30,0	52,0	7,0	BAG	H	NBR	02006BAG	20
30,0	52,0	7,0	BRAG	H	FPM	05073BRAGF	20
30,0	52,0	8,0	BR	LI	NBR	00952BR	20
30,0	52,0	8,0	BRG	LI	NBR	02813BRG	20
30,0	52,0	9,0	B	LI	MVQ	01743BS	20
30,0	52,0	9,0	B	LI	NBR	02401B	20
30,0	52,0	10,0	BR	LI	NBR	00949BR	20
30,0	52,0	12,0	BA	AH	NBR	01952BA	20
30,0	55,0	12,0	BA	LI	NBR	00772BA	20
30,0	56,0	12,0	BR	LI	NBR	00817BR	20
30,0	58,1	11,0	BA	AH	NBR	07299BA	20
30,0	62,0	10,1	BA	LI	NBR	01273BA	20
30,0	72,0	9,5	BR	LI	NBR	01182BR	20
30,3	39,7	6,4	BR	H	NBR	01992BR	20
31,0	47,0	7,0	BR	LI	NBR	00762BR	20
31,0	50,0	8,0	BRAG	H	FPM	02317BRAGF	20
31,7	42,8	7,9	BAG	LI	NBR	01630BAG	20
31,7	42,9	5,0	GR	LI	NBR	00114GR	20

Diámetro Eixo	Diámetro Alojamento	Altura Retentor	Tipo	Orien-tación	Material Lábío	Nº SABO	Página
31,7	44,5	6,5	BR	LI	NBR	01149BR	20
31,7	44,5	8,0	BR	LI	NBR	00343BR	20
31,7	44,5	9,5	B	LI	NBR	01154B	20
31,7	50,7	11,0	B	LI	NBR	00028B	20
31,7	50,8	9,5	B	LI	NBR	00774B	20
31,7	50,8	11,1	BAG	LI	NBR	02063BAG	20
31,7	52,3	9,5	B	LI	NBR	01377B	20
31,8	42,8	9,5	B	LI	NBR	00017B	20
31,8	44,5	6,5	BA	H	NBR	01149BA	20
31,9	44,0	9,0	BA	LI	NBR	01370BA	20
32,0	42,0	7,0	BAG	LI	NBR	01310BAG	20
32,0	42,0	7,0 / 8,0	BRAG	H	FPM	05159BRAGF	20
32,0	43,0	7,0	BR	LI	NBR	01715BR	20
32,0	44,0	6,0	BRG	H	FPM	05580BRGF	20
32,0	45,0	6,5	GR	LI	NBR	02987GR	20
32,0	45,0	7,0	BA	LI	NBR	00495BA	20
32,0	45,0	7,0	BRG	AH	NBR	02397BRG	20
32,0	45,0	7,0	BRG	LI	NBR	02984BRG	20
32,0	46,0	6,0	BRG	H	ACM	05784BRGP	20
32,0	47,0	10,0	BRG	H	ACM	01942BRGP	20
32,0	47,0	10,0	BRG	BI	FPM	02142BRGF	20
32,0	47,0	10,0	BRG	H	FPM	02842BRGF	20
32,0	47,5	6,4	BA	LI	NBR	01563BA	20
32,0	48,0	8,0	BRG	H	ACM	05529BRGP	20
32,0	50,0	8,0	BR	LI	MVQ	00839BR	20
32,0	51,9	20,0	BRG	LI	NBR	01353BRG	20
32,0	52,0	7,0	BRG	LI	NBR	02699BRG	20
32,0	52,0	9,0	B	LI	NBR	01744B	20
32,0	52,1	10,0	BR	LI	NBR	00801BR	20
32,0	57,1	9,5	BA	LI	NBR	00477BA	20
33,0	44,0	8,0	BAG	LI	NBR	07687BAG	20
33,0	45,0	7,0	BR	LI	FPM	02020BRF	20
33,0	50,0	8,0	BA	H	NBR	01839BA	20
33,0	51,9	20,0	BAG	BI	NBR	01849BAG	20
33,0	52,0	6,0	BR	LI	NBR	01589BR	20
33,3	69,4	7,9	BA	LI	NBR	01040BA	20
34,0	48,0	7,0	BRG	H	ACM	05307BRGP	20
34,0	52,0	7,5	BR	LI	NBR	01509BR	20
34,0	62,0	10,0	BR	LI	NBR	01157BR	20
34,9	50,8	8,3	BA	LI	NBR	02221BA	20
34,9	50,9	8,3	BA	H	NBR	02102BA	20
34,9	52,3	9,5	B	LI	NBR	01395B	20
34,9	53,5	6,5	GA	LI	NBR	02315GA	20
34,9	55,9	20,5	BAG	AH	NBR	01844BAG	20
34,9	63,0	13,0	BAG	H	NBR	01343BAG	20
35,0	42,0	4,0	GA	LI	NBR	02095GA	20
35,0	42,0	4,0	GR	LI	NBR	02632GR	20
35,0	44,5	7,0	BA	LI	NBR	01502BA	20
35,0	45,0	7,0	BA	LI	NBR	00822BA	20

## TIPOS BÁSICOS

Diâmetro Eixo	Diâmetro Alojamento	Altura Retentor	Tipo	Orientação	Material Lábio	Nº SABÓ	Página	Diâmetro Eixo	Diâmetro Alojamento	Altura Retentor	Tipo	Orientação	Material Lábio	Nº SABÓ	Página
35,0	46,5	6,4	BRG	LI	NBR	01526BRG	20	36,0	54,0	7,5	BR	LI	NBR	01421BR	20
35,0	46,5	4,8	GR	LI	NBR	01152GR	20	36,0	60,0	9,5	BRG	BI	NBR	01814BRG	20
35,0	47,0	7,0	BA	LI	NBR	00485BA	20	36,5	57,1	12,7	B	LI	NBR	00218B	20
35,0	47,0	7,0	BRG	BI	FPM	02962BRGF	20	37,0	47,0	10,2	BRG	H	FPM	05363BRGF	20
35,0	47,0	7,0	BR	H	MVQ	05508BRS	20	37,0	50,0	6,0	BRG	H	ACM	05782BRGP	20
35,0	47,0	7,0	BR	H	MVQ	05658BRS	20	38,0	47,6	6,5	BA	LI	NBR	02505BA	20
35,0	47,1	9,0	BR	LI	NBR	00969BR	20	38,0	50,0	7,0	BA	LI	NBR	00486BA	20
35,0	47,1	10,0	BR	LI	NBR	00520BR	20	38,0	50,0	8,0	BRAG	H	FPM	02794BRAGF	20
35,0	47,6	9,5	B	LI	NBR	01041B	20	38,0	52,0	10,0	BR	LI	NBR	00479BR	20
35,0	48,0	7,0	BRAG	H	MVQ	02178BRAGS	20	38,0	52,0	10,0	BRG	LI	NBR	00479BRG	20
35,0	50,0	7,0	BRG	H	FPM	05253BRGF	20	38,0	52,3	7,0	BR	LI	NBR	02506BR	20
35,0	50,0	8,0	BR	H	ACM	00962BR	20	38,0	54,0	10,0	BR	LI	NBR	02051BR	20
35,0	50,0	8,0	BRG	H	ACM	00962BRGP	20	38,0	57,0	7,0	BA	LI	NBR	01657BA	20
35,0	50,0	8,0	BRG	H	MVQ	02456BRGS	20	38,0	58,5	7,0	BR	BI	NBR	01832BR	20
35,0	50,0	8,0	BRG	BI	FPM	05511BRGF	20	38,0	62,0	7,0	BA	LI	NBR	02128BA	20
35,0	50,0	10,0	BA	LI	NBR	00789BA	20	38,0	70,0	12,7	B	LI	NBR	01318B	20
35,0	50,0	10,0	BR	LI	NBR	00789BR	20	38,0	74,0	11,0	BAG	LI	NBR	01710BAG	20
35,0	50,0	10,0	BRG	H	MVQ	05313BRGS	20	38,0	74,0	11,0	BAG	H	NBR	02289BAG	20
35,0	52,0	12,0	BRG	LI	NBR	00912BRG	20	38,1	47,6	6,4	BA	LI	NBR	01536BA	20
35,0	52,1	10,0	BR	LI	NBR	01742BR	20	38,1	47,6	7,0	BA	H	NBR	02385BA	20
35,0	52,1	12,0	BR	LI	NBR	00758BR	20	38,1	50,1	7,0	BR	LI	NBR	01355BR	20
35,0	52,3	9,5	BR	LI	NBR	00879BR	20	38,1	50,4	11,0	BAG	LI	NBR	01803BAG	20
35,0	53,9	9,5	B	LI	NBR	00694B	20	38,1	60,3	12,7	B	LI	NBR	00049B	20
35,0	54,0	11,0	BR	LI	NBR	00214BR	20	38,1	60,3	12,7	BAG	AH	NBR	00049BAG	20
35,0	54,9	11,0	BAG	LI	NBR	01371BAG	20	38,1	60,4	12,7	BRG	H	NBR	01854BRG	20
35,0	55,0	8,0	BR	LI	NBR	01980BR	20	38,1	63,5	12,7	BR	LI	NBR	00019BR	20
35,0	55,0	8,0	BAG	BI	NBR	07695BAG	20	38,1	63,6	12,7	BRG	H	NBR	02034BRG	20
35,0	55,5	6,4	BR	LI	NBR	00284BR	20	38,2	60,4	12,7	BAG	AH	NBR	01877BAG	20
35,0	56,0	10,0	BAG	BI	NBR	02087BAG	20	38,2	63,5	11,1	BA	BI	NBR	00995BA	20
35,0	56,0	10,0	BR	AH	NBR	02224BR	20	39,1	62,2	6,4	GA	LI	NBR	00373GA	20
35,0	56,1	12,0	BA	LI	NBR	00492BA	20	39,4	63,6	12,5	BRG	AH	NBR	02438BRG	20
35,0	57,9	6,4	GA	LI	NBR	00258GA	20	39,4	63,6	12,7	BRG	BI	NBR	02038BRG	20
35,0	58,0	10,0	BR	LI	NBR	01551BR	20	39,7	61,2	12,7	B	LI	NBR	00016B	20
35,0	58,0	10,0	BR	BI	NBR	01905BR	20	39,7	63,5	12,7	B	LI	NBR	01811B	20
35,0	60,3	9,5	BRG	LI	NBR	02304BRG	20	40,0	50,0	4,0	GA	LI	NBR	01419GA	20
35,0	62,0	9,5	BA	LI	NBR	00800BA	20	40,0	50,0	4,0	GR	LI	NBR	02633GR	20
35,0	62,0	10,0	BR	AH	NBR	01949BR	20	40,0	52,0	6,0	BRG	LI	NBR	02822BRG	20
35,0	62,0	12,0	BA	LI	NBR	00136BA	20	40,0	52,0	7,0	BR	H	FPM	08312BRF	20
35,0	63,1	14,0	BRG	LI	NBR	02303BRG	20	40,0	52,0	7,4	BRG	LI	NBR	01988BRG	20
35,0	65,0	8,0	BRAG	BI	FPM	02481BRAGF	20	40,0	52,0	9,0	BRG	BI	ACM	02068BRGP	20
35,0	72,0	10,0	B	LI	NBR	01366B	20	40,0	55,0	7,0	BRAG	H	FPM	05246BRAGF	20
35,0	80,0	6,0	BA	LI	NBR	02151BA	20	40,0	55,0	8,0	BRG	LI	NBR	01707BRG	20
35,0	80,0	12,0	BR	H	NBR	01954BR	20	40,0	55,0	8,0	BRG	BI	NBR	02391BRG	20
35,5	58,2	13,0	BAG	BI	NBR	01004BAG	20	40,0	55,0	8,0	BAG	BI	NBR	02972BAG	20
36,0	50,0	8,0	BRG	H	FPM	04247BRGF	20	40,0	55,0	8,0	BRG	H	ACM	07021BRGP	20
36,0	54,0	7,0	BA	LI	NBR	00797BA	20	40,0	55,0	8,0	BRAG	BI	ACM	07284BRAGP	20
36,0	54,0	7,0	BR	LI	NBR	00797BR	20	40,0	55,0	9,0	B	LI	NBR	01155B	20
36,0	54,0	7,0	BA	H	NBR	02099BA	20	40,0	55,0	9,5	BAG	BI	NBR	02419BAG	20
36,0	54,0	7,0	BRAG	H	FPM	07598BRAGF	20	40,0	55,0	10,0	BRG	H	ACM	07717BRGP	20

Diámetro Eixo	Diámetro Alojamento	Altura Retentor	Tipo	Orien-tación	Material Lábío	N° SABO	Página
40,0	55,1	10,0	BR	LI	NBR	01745BR	20
40,0	56,0	7,0	BAG	H	ACM	02005BAGP	20
40,0	56,0	7,0	BR	LI	NBR	02031BR	20
40,0	56,0	7,0	BAG	H	FPM	02302BAGF	20
40,0	56,0	7,0	BRAG	H	FPM	02844BRAGF	20
40,0	56,0	8,0	BR	LI	NBR	00880BR	20
40,0	56,0	9,0	BAG	LI	NBR	01265BAG	20
40,0	56,0	10,0	BAG	LI	NBR	01046BAG	20
40,0	57,0	12,0	BR	LI	NBR	00924BR	20
40,0	60,0	10,0	BR	LI	NBR	01116BR	20
40,0	60,0	12,0	BR	LI	NBR	00897BR	20
40,0	62,0	11,5	BR	LI	NBR	01109BR	20
40,0	62,0	11,5	BRG	LI	NBR	01109BRG	20
40,0	62,0	12,0	BG	LI	NBR	02377BG	20
40,0	62,1	10,0	BR	LI	NBR	01322BR	20
40,0	65,0	12,0	BAG	LI	NBR	01266BAG	20
40,0	68,0	12,0	BR	AH	NBR	02225BR	20
40,0	70,0	12,0	B	LI	NBR	00837B	20
40,0	72,0	12,0	BAG	LI	NBR	01602BAG	20
40,0	80,0	10,0	BR	LI	NBR	00913BR	20
40,0	82,9	10,0	BRG	BI	NBR	02675BRG	20
40,5	54,0	7,2	BAG	BI	MVQ	01958BAGS	20
41,0	49,3	6,5	BAG	H	NBR	01963BAG	20
41,0	65,4	13,0	BAG	BI	NBR	01100BAG	20
41,1	50,8	5,9	BA	LI	NBR	03161BA	20
41,2	63,5	8,0	BAG	H	ACM	02084BAGP	20
41,3	63,6	6,5	BAG	BI	ACM	02053BAGP	20
41,3	63,6	12,7	BR	LI	NBR	00133BR	20
41,4	70,6	7,9	BAG	LI	NBR	01931BAG	20
42,0	53,0	7,0	BRG	H	FPM	05250BRGF	20
42,0	55,0	9,0	BAG	LI	FPM	02058BAGF	20
42,0	55,0	10,0	BRAG	AH	FPM	02682BRAGF	20
42,0	56,0	7,0	BR	LI	NBR	00288BR	20
42,0	56,0	7,0	BAG	LI	NBR	02321BAG	20
42,0	58,0	7,0	BA	LI	NBR	02059BA	20
42,0	60,0	9,0	BRG	AH	NBR	02296BRG	20
42,0	60,0	10,0	BRG	H	FPM	05774BRGF	20
42,0	62,0	6,0	BR	LI	NBR	01802BR	20
42,0	62,0	7,0	BRG	H	FPM	05510BRGF	20
42,0	62,1	10,0	BR	LI	NBR	00521BR	20
42,0	64,9	12,0	BAG	LI	NBR	00561BAG	20
42,0	65,0	12,0	B	LI	FPM	01506BF	20
42,0	65,1	10,0	BR	LI	NBR	01505BR	20
42,0	66,0	6,0	BRG	H	FPM	05591BRGF	20
42,0	72,0	10,0	BR	AH	NBR	02039BR	20
42,0	72,0	10,0	BRAG	H	FPM	02494BRAGF	20
42,0	72,0	12,0	BR	LI	NBR	01081BR	20
43,0	62,0	10,0	BR	LI	NBR	00604BR	20

Diámetro Eixo	Diámetro Alojamento	Altura Retentor	Tipo	Orien-tación	Material Lábío	N° SABO	Página
44,0	58,0	7,0	BA	LI	NBR	02295BA	20
44,0	60,0	7,0	BRG	H	FPM	05775BRGF	20
44,0	60,0	10,0	BR	LI	NBR	01552BR	20
44,0	76,1	20,7	BR	LI	NBR	00219BR	20
44,0	79,9	20,0	BA	LI	NBR	00775BA	20
44,2	71,5	14,8	BAG	H	NBR	01119BAG	20
44,3	60,0	7,0	BR	LI	NBR	02378BR	20
44,3	81,0	20,5	BR	LI	NBR	02196BR	20
44,4	63,5	20,7	BAG	BI	NBR	02580BAG	20
44,5	54,0	4,8	BA	LI	NBR	00749BA	20
44,5	57,2	9,4	BR	LI	NBR	00734BR	20
44,5	61,9	9,5	BAG	H	NBR	01859BAG	20
44,5	62,0	11,0	BRG	BI	NBR	01095BRG	20
44,5	63,6	8,0	BA	H	NBR	02104BA	20
44,5	65,1	8,0	BR	LI	NBR	01532BR	20
44,5	66,7	20,7	BR	LI	NBR	00208BR	20
44,5	68,2	15,9	BRG	LI	NBR	01679BRG	20
44,5	69,8	20,7	B	LI	NBR	00069B	20
44,5	70,0	10,0	BR	LI	NBR	01656BR	20
44,5	73,0	20,0	B	LI	NBR	00276B	20
44,5	79,9	11,1	BA	LI	NBR	00554BA	20
44,7	61,2	8,8	BRAG	H	FPM	02862BRAGF	20
44,7	61,2	9,5	BAG	H	NBR	00222BAG	20
45,0	55,0	4,0	GR	LI	NBR	02634GR	20
45,0	60,0	7,0	BRG	LI	NBR	00272BRG	20
45,0	60,0	7,0	BRG	LI	NBR	02745BRG	20
45,0	60,0	9,0	BRG	H	NBR	01911BRG	20
45,0	60,0	9,0	BRG	H	FPM	01911BRGF	20
45,0	60,0	10,0	B	LI	NBR	01738B	20
45,0	60,0	10,0	BRG	H	NBR	01851BRG	20
45,0	62,0	7,0	BA	LI	NBR	02169BA	20
45,0	62,0	8,0	GR	LI	NBR	01760GR	20
45,0	62,0	9,0	BRG	LI	NBR	02110BRG	20
45,0	62,0	9,0	BRG	AH	NBR	02298BRG	20
45,0	62,0	10,0	BRG	LI	NBR	00063BRG	20
45,0	64,0	9,0	BRG	LI	NBR	01711BRG	20
45,0	65,0	20,0	BR	LI	NBR	01344BR	20
45,0	65,0	8,0	BRG	LI	NBR	02324BRG	20
45,0	65,0	10,0	BR	LI	NBR	00359BR	20
45,0	65,0	10,0	BRAG	H	FPM	07365BRAGF	20
45,0	66,2	6,0	BR	LI	NBR	01141BR	20
45,0	67,0	8,0	BRG	H	FPM	05809BRGF	20
45,0	67,9	20,0	BAG	LI	NBR	02007BAG	20
45,0	72,0	9,5	BR	LI	NBR	01553BR	20
45,0	72,0	10,0	BA	LI	NBR	01906BA	20
45,0	72,0	20,0	BR	LI	NBR	00509BR	20
45,0	85,0	13,0	B	LI	NBR	01038B	20
46,0	62,0	7,0	B	LI	NBR	00302B	20
46,0	64,0	8,0	BRAG	H	FPM	07809BRAGF	20

## TIPOS BÁSICOS

Diâmetro Eixo	Diâmetro Alojamento	Altura Retentor	Tipo	Orien- tação	Material Lábio	Nº SABÓ	Página	Diâmetro Eixo	Diâmetro Alojamento	Altura Retentor	Tipo	Orien- tação	Material Lábio	Nº SABÓ	Página
46,0	68,0	12,0	BA	H	FPM	07599BAF	20	50,0	72,1	10,0	BR	LI	NBR	00834BR	20
46,3	66,6	6,4	BA	LI	NBR	00849BA	20	50,0	87,0	12,7	BAG	LI	NBR	01855BAG	20
46,7	62,0	9,0	BRG	H	FPM	05353BRGF	20	50,8	65,1	12,7	BAG	LI	NBR	02262BAG	20
47,0	62,1	8,0	BR	LI	NBR	01140BR	20	50,8	65,1	12,7	GA	LI	NBR	01671GA	20
47,6	57,2	5,0	BA	H	FPM	02558BAF	20	50,8	69,9	11,0	BRG	H	ACM	05308BRGP	20
47,6	63,6	9,7	BAG	H	ACM	02990BAGP	20	50,8	71,9	11,9	B	LI	NBR	01878B	20
47,6	66,6	12,7	B	LI	NBR	00405B	20	50,8	73,0	12,7	B	LI	NBR	00630B	20
47,6	69,8	12,7	B	LI	NBR	00155B	20	50,8	76,3	12,7	BR	LI	NBR	00048BR	20
47,6	69,9	9,5	BR	LI	NBR	01699BR	20	50,8	79,9	10,0	BA	LI	NBR	00752BA	20
47,6	70,5	13,5	BA	LI	NBR	01369BA	20	50,8	80,0	12,7	B	LI	NBR	00660B	20
47,6	82,8	11,0	B	LI	NBR	01460B	20	50,9	69,8	9,5	BR	LI	NBR	00586BR	20
47,7	65,0	8,0	BR	H	NBR	02055BR	20	50,9	69,8	9,5	BRG	H	NBR	00586BRG	20
47,7	73,0	12,0	B	LI	NBR	00674B	20	52,0	70,0	9,0	BAG	BI	NBR	07700BAG	20
48,0	62,0	7,0	BRG	BI	ACM	07366BRGP	20	52,0	72,0	10,0	BAG	H	NBR	01950BAG	20
48,0	62,0	8,0	BA	LI	NBR	00566BA	20	52,0	72,0	12,0	B	LI	NBR	00047B	20
48,0	65,0	10,0	B	LI	NBR	00527B	20	52,0	72,0	12,0	BAG	LI	FPM	00047BAGF	20
48,0	65,0	10,0	BR	H	FPM	08313BRAAF	20	52,0	80,1	10,0	BR	LI	NBR	00867BR	20
48,0	65,1	7,0	BRG	LI	NBR	01147BRG	20	52,4	76,2	7,9	BA	LI	NBR	00974BA	20
48,0	65,5	7,0	BAGG	LI	NBR	02833BAGG	20	52,4	81,0	11,5	B	LI	NBR	00005B	20
48,0	69,0	10,0	BA	H	FPM	07485BAF	20	53,0	69,9	11,0	BRG	H	ACM	05309BRGP	20
48,0	69,0	10,0	BA	H	FPM	07612BAF	20	53,0	75,0	12,0	B	LI	NBR	00838B	20
48,0	70,0	9,0	BRG	BI	NBR	07699BRG	20	53,0	82,0	7,5	GA	LI	NBR	07023GA	20
48,0	72,0	7,0	BRG	LI	NBR	02139BRG	20	53,8	77,7	12,7	BA	LI	NBR	00006BA	20
48,0	72,0	10,0	BRG	LI	NBR	00161BRG	20	53,9	73,0	12,7	B	LI	NBR	00037B	20
48,0	72,0	10,0	BR	H	NBR	01902BR	20	53,9	81,1	12,0	BRG	LI	NBR	00231BRG	20
48,0	72,1	7,0	BRG	LI	NBR	00522BRG	20	54,0	65,0	8,0	BA	LI	NBR	01278BA	20
48,0	75,0	8,0	BA	H	FPM	02723BAF	20	54,0	72,0	8,0	BR	LI	NBR	00563BR	20
49,0	65,0	10,0	BAG	LI	NBR	01241BAG	20	54,0	73,0	9,5	BRG	AH	NBR	02197BRG	20
49,0	68,0	12,0	BAG	LI	NBR	01262BAG	20	54,0	73,0	11,0	BAG	BI	ACM	02207BAGP	20
49,0	75,0	11,0	BR	LI	NBR	01017BR	20	54,0	76,0	8,0	BRG	AH	NBR	01825BRG	20
49,2	65,0	8,0	BR	LI	NBR	00708BR	20	54,0	76,2	12,7	BAG	LI	NBR	01864BAG	20
49,2	69,9	9,5	BA	LI	NBR	00072BA	20	54,0	79,4	9,5	BG	BI	ACM	02287BGP	20
49,2	76,1	12,7	BR	LI	NBR	00291BR	20	54,0	79,4	12,7	BAG	LI	NBR	00436BAG	20
49,2	76,1	12,7	B	LI	NBR	00291B	20	54,0	79,4	12,7	BAG	AH	NBR	01838BAG	20
49,2	79,4	12,5	BR	H	NBR	01994BR	20	54,0	90,0	12,5	BAG	BI	ACM	02205BAGP	20
49,2	80,9	11,0	B	LI	NBR	00229B	20	54,1	73,0	8,5	BAG	LI	NBR	01930BAG	20
50,0	65,0	8,0	BR	LI	NBR	01422BR	20	55,0	65,0	5,0	GR	LI	NBR	02635GR	20
50,0	65,0	8,0	BRAG	AH	FPM	07880BRAGF	20	55,0	68,0	4,0	GR	LI	NBR	01035GR	20
50,0	65,0	8,5	BRG	LI	NBR	01783BRG	20	55,0	70,0	8,0	BR	LI	NBR	01181BR	20
50,0	65,0	9,0	BAG	LI	NBR	07820BAG	20	55,0	70,0	8,0	BRAG	H	FPM	05537BRAGF	20
50,0	65,0	10,0	B	LI	NBR	01740B	20	55,0	70,1	8,0	BRA	AH	FPM	02656BRAAF	20
50,0	68,0	9,0	BRG	LI	NBR	02108BRG	20	55,0	70,1	11,5	BR	LI	NBR	01557BR	20
50,0	68,0	10,0	BR	LI	NBR	01340BR	20	55,0	72,0	9,0	BRG	LI	NBR	02111BRG	20
50,0	68,0	10,0	BRG	H	MVQ	05306BRGS	20	55,0	72,0	10,0	BR	LI	NBR	01550BR	20
50,0	70,0	10,0	BR	LI	NBR	00946BR	20	55,0	72,0	10,0	BR	LI	ACM	01550BRP	20
50,0	70,0	10,0	BRG	H	FPM	05683BRG	20	55,0	72,0	10,0	BRG	H	MVQ	01969BRGS	20
50,0	70,0	12,0	BAG	LI	NBR	01807BAG	20	55,0	75,0	8,0	BRG	LI	ACM	03321BRG	20
50,0	71,9	12,0	BR	LI	NBR	00162BR	20	55,0	75,0	8,0	BA	H	FPM	07691BAF	20
50,0	72,0	12,0	BRG	LI	NBR	01861BRG	20	55,0	75,0	10,0	BR	LI	NBR	00804BR	20



Diâmetro Eixo	Diâmetro Alojamento	Altura Retentor	Tipo	Orien-tação	Material Lábio	N° SABO	Página
55,0	75,0	12,0	B	LI	NBR	00620B	20
55,0	76,0	12,0	BA	LI	NBR	01247BA	20
55,0	80,0	8,0	BRG	H	NBR	02529BRG	20
55,0	80,0	10,0	BR	LI	NBR	00459BR	20
55,0	80,0	13,0	BR	LI	NBR	00498BR	20
55,0	85,0	13,0	BR	LI	NBR	01180BR	20
55,0	90,0	10,0	BA	LI	NBR	00793BA	20
55,0	90,0	12,5	B	LI	NBR	00964B	20
55,0	100,0	12,7	BR	LI	NBR	01669BR	20
55,1	82,0	10,0	GA	LI	NBR	01637GA	20
55,4	76,2	12,7	BAG	LI	NBR	02415BAG	20
57,0	71,0	9,0	BRG	H	FPM	05352BRGF	20
57,0	85,0	12,0	BA	BI	ACM	02236BAP	20
57,1	80,0	13,0	B	LI	NBR	00735B	20
57,2	73,0	8,0	BAG	BI	NBR	02066BAG	20
57,2	77,8	10,0	BRG	BI	ACM	02667BRGP	20
57,2	79,3	12,7	B	LI	NBR	00146B	20
57,2	81,0	12,7	B	LI	NBR	00109B	20
57,2	82,5	12,7	BA	LI	NBR	00321BA	20
57,3	76,2	9,5	BAG	LI	NBR	01862BAG	20
57,3	76,2	12,7	B	LI	NBR	00013B	20
57,3	76,2	12,7	BRG	LI	NBR	00013BRG	20
57,3	84,0	8,0	BA	LI	NBR	00188BA	20
58,0	72,0	7,0	BRAG	H	FPM	03478BRAGF	20
58,0	74,0	10,0	BRG	AH	FPM	05305BRGF	20
58,0	75,0	9,0	BRG	LI	NBR	02112BRG	20
58,0	75,0	9,0	BRG	AH	NBR	02426BRG	20
58,0	75,0	12,0	BAG	AH	NBR	02100BAG	20
58,0	80,0	12,0	BRG	H	ACM	02326BRGP	20
58,0	85,0	13,0	BAG	LI	NBR	01798BAG	20
58,7	79,4	9,6	BR	H	NBR	01995BR	20
58,7	85,0	8,0	BA	LI	NBR	00070BA	20
59,5	85,6	12,0	B	LI	NBR	00547B	20
60,0	72,0	6,0	GR	LI	NBR	02636GR	20
60,0	73,0	10,5	BRAG	BI	FPM	07484BRAGF	20
60,0	75,0	8,0	BR	LI	NBR	00501BR	20
60,0	75,0	8,0	BRAG	BI	ACM	07453BRAGP	20
60,0	76,2	11,1	BRG	AH	FPM	05126BRF	20
60,0	78,1	8,8	BAG	LI	NBR	00305BAG	20
60,0	80,0	10,0	BR	AH	NBR	00223BR	20
60,0	80,0	12,0	BAG	LI	NBR	01392BAG	20
60,0	80,0	13,0	BR	LI	NBR	00818BR	20
60,0	82,0	12,0	BR	LI	NBR	00977BR	20
60,0	82,0	12,0	BRG	AH	NBR	01841BRG	20
60,0	82,0	12,0	BRG	H	NBR	01842BRG	20
60,0	85,0	12,7	BR	LI	NBR	01194BR	20
60,0	90,0	8,0	BR	LI	NBR	02685BR	20
60,0	90,0	10,0	BR	LI	NBR	00517BR	20
60,2	85,8	9,5	BA	BI	NBR	01755BA	20

Diâmetro Eixo	Diâmetro Alojamento	Altura Retentor	Tipo	Orien-tação	Material Lábio	N° SABO	Página
60,3	79,4	9,5	BAG	H	NBR	02077BAG	20
60,3	79,4	20,0	BAG	BI	ACM	02206BAGP	20
60,3	82,5	11,0	BA	H	ACM	02116BAP	20
60,3	82,5	11,0	BRAG	H	FPM	02448BRAGF	20
60,3	85,0	20,0	B	LI	NBR	00371B	20
60,3	85,1	6,4	BA	LI	NBR	01345BA	20
60,3	90,0	20,5	BAG	LI	ACM	02204BAGP	20
60,3	92,0	20,0	BAG	H	NBR	00334BAG	20
60,4	79,4	9,3	BR	LI	NBR	01050BR	20
60,4	79,4	9,3	BRG	H	MVQ	01050BRGS	20
60,4	79,4	9,3	BRG	H	FPM	02578BRGF	20
61,9	80,0	10,0	B	LI	NBR	01828B	20
62,0	85,0	10,0	BR	LI	NBR	00460BR	20
62,0	85,0	13,0	BR	LI	NBR	00044BR	20
62,0	100,1	17,0	BA	LI	NBR	01425BA	20
63,0	80,0	20,0	BAG	BI	NBR	07823BAG	20
63,5	76,1	9,5	BR	LI	NBR	00907BR	20
63,5	82,5	20,7	B	LI	NBR	01790B	20
63,5	82,6	20,7	BAG	AH	FPM	02478BAGF	20
63,5	88,9	11,0	BRG	H	FPM	02498BRGF	20
63,5	88,9	20,7	BAG	LI	NBR	00200BAG	20
63,5	88,9	20,7	BA	LI	NBR	01863BA	20
63,5	88,9	17,8	BG	LI	NBR	00652BG	20
63,5	89,9	20,0	B	LI	NBR	00378B	20
64,0	80,0	8,0	BAG	AH	ACM	02004BAGP	20
64,0	80,0	8,0	BRAG	AH	FPM	05062BRAGF	20
64,0	80,0	9,0	BRAG	H	FPM	05055BRAGF	20
65,0	80,0	8,0	BR	LI	NBR	01160BR	20
65,0	85,0	10,0	BRG	LI	NBR	02530BRG	20
65,0	85,1	10,0	BR	LI	NBR	00926BR	20
65,0	88,5	20,7	BA	LI	NBR	00903BA	20
65,0	90,0	10,0	BR	LI	NBR	00051BR	20
65,0	90,0	13,0	BAG	LI	NBR	00164BAG	20
65,0	90,0	13,0	BR	LI	NBR	00164BR	20
65,0	90,0	15,0	BAG	H	MVQ	01810BAGS	20
65,0	90,0	15,0	BRAG	H	FPM	01810BRAGF	20
65,0	100,0	13,0	BR	AH	NBR	02113BR	20
66,7	85,6	20,0	BG	BI	ACM	02272BGP	20
66,7	88,8	11,0/20,5	BRAG	H	FPM	02511BRAGF	20
66,7	88,9	20,7	BR	LI	NBR	00369BR	20
66,7	92,0	11,0	BG	BI	ACM	02271BGP	20
66,7	92,0	20,0	B	LI	NBR	00030B	20
66,7	95,3	20,7	BR	LI	NBR	00379BR	20
66,7	200,7	11,0	B	LI	NBR	00434B	20
68,0	85,0	10,0	BA	H	FPM	02556BAF	20
68,0	85,0	10,0	BRG	LI	NBR	02557BRG	20
68,0	85,0	10,0	BRA	H	FPM	07603BRAf	20
68,0	90,0	10,0	BAG	LI	NBR	00228BAG	20
68,0	90,0	10,0	BA	AH	FPM	02292BAF	20

## TIPOS BÁSICOS

Diâmetro Eixo	Diâmetro Alojamento	Altura Retentor	Tipo	Orientação	Material Lábio	Nº SABÓ	Página	Diâmetro Eixo	Diâmetro Alojamento	Altura Retentor	Tipo	Orientação	Material Lábio	Nº SABÓ	Página
68,0	90,0	10,0	BR	LI	NBR	02445BR	20	75,9	95,0	11,3	BRG	AH	ACM	01856BRGP	20
68,0	90,0	13,0	BAG	H	FPM	00500BAG	20	76,2	98,5	11,9	B	LI	NBR	01857B	20
68,0	90,0	13,0	BAG	H	FPM	00500BAGF	20	76,2	101,7	12,0	B	LI	NBR	00357B	20
68,0	90,0	13,0	BAG	H	ACM	00500BAGP	20	76,2	101,7	12,0	BA	LI	NBR	00357BA	20
69,0	85,0	10,0	BAG	LI	NBR	07822BAG	20	78,0	100,0	13,0	BRG	H	MVQ	01917BRGS	20
69,8	90,0	10,0	BAG	LI	NBR	02423BAG	20	78,0	100,1	12,0	BRAG	H	FPM	02871BRAGF	20
69,8	92,0	14,2	BRG	LI	NBR	00891BRG	20	78,0	110,0	13,0	BR	LI	NBR	00819BR	20
69,8	95,2	12,7	B	LI	NBR	00376B	20	79,0	95,3	11,0	BRAG	AH	FPM	05166BRAGF	20
69,8	98,5	11,8	BAG	H	NBR	01880BAG	20	79,4	104,7	12,7	B	LI	NBR	00221B	20
69,9	89,0	12,7	BA	AH	NBR	02085BA	20	79,4	114,3	12,7	BR	LI	NBR	01148BR	20
69,9	98,5	12,7	B	LI	NBR	00081B	20	80,0	96,0	9,0	BRG	AH	FPM	05776BRGF	20
70,0	81,5	6,0	GR	LI	NBR	07684GR	20	80,0	98,0	10,0	BRAG	AH	FPM	02702BRAGF	20
70,0	85,0	7,0	GR	LI	NBR	02637GR	20	80,0	100,0	8,0	BRG	AH	FPM	05601BRGF	20
70,0	85,0	8,0	BR	LI	NBR	00906BR	20	80,0	100,0	10,0	BR	LI	NBR	00610BR	20
70,0	85,0	8,0	BAG	AH	ACM	02269BAGP	20	80,0	100,0	10,0	BAG	BI	ACM	02664BAGP	20
70,0	85,0	8,0	BAG	AH	FPM	02297BAGF	20	80,0	100,0	10,0	BRG	H	FPM	05675BRGF	20
70,0	85,0	8,0	BRG	LI	NBR	02677BRG	20	80,0	100,0	12,0	BAG	H	MVQ	02235BAGS	20
70,0	85,0	8,0	BRAG	AH	FPM	02845BRAGF	20	80,0	100,0	12,0	BA	H	FPM	02291BAF	20
70,0	86,0	7,0	BRG	AH	FPM	05599BRGF	20	80,0	100,0	12,0	BRG	AH	NBR	02662BRG	20
70,0	88,0	10,0	BRAG	AH	FPM	08427BRAGF	20	80,0	100,0	13,0	BR	AH	MVQ	05302BRS	20
70,0	90,0	10,0	BR	AH	NBR	01135BR	20	80,0	110,0	12,0	BR	LI	NBR	00900BR	20
70,0	90,0	10,0	BRG	AH	MVQ	01135BRGS	20	81,0	117,5	14,3	B	LI	NBR	00002B	20
70,0	90,0	10,0	BR	AH	ACM	01135BRP	20	82,0	104,7	14,3	B	LI	NBR	00593B	20
70,0	90,0	10,0	BRG	BI	ACM	02192BRGP	20	82,0	105,0	12,0	BRG	AH	MVQ	01945BRGS	20
70,0	90,0	10,0	BRG	AH	ACM	05815BRGP	20	82,5	107,9	11,9	B	LI	NBR	00644B	20
70,0	90,0	13,0	BR	LI	NBR	00490BR	20	82,5	114,3	12,7	BG	BI	NBR	01923BG	20
70,0	90,5	10,0	BR	AH	ACM	01927BRP	20	82,5	120,0	15,0	BAG	BI	NBR	02416BAG	20
70,0	95,0	13,0	BRG	AH	NBR	01879BRG	20	82,6	107,9	14,3	B	LI	NBR	01195B	20
70,0	100,0	10,0	BR	LI	NBR	00866BR	20	84,0	110,1	16,0	BR	LI	NBR	00612BR	20
70,0	100,0	12,0	BR	LI	NBR	00423BR	20	85,0	105,0	9,0	BRG	AH	FPM	05590BRGF	20
72,2	100,0	12,7	B	LI	NBR	00087B	20	85,0	105,0	10,0	BA	H	FPM	02606BAF	20
73,0	95,2	12,7	B	LI	NBR	00098B	20	85,0	105,0	10,0	BA	AH	FPM	02801BAF	20
73,0	101,6	12,7	B	LI	NBR	00116B	20	85,0	105,0	11,0	BRG	LI	NBR	02607BRG	20
74,0	90,0	10,0	BAG	LI	NBR	01044BAG	20	85,0	105,0	12,0	BRG	AH	MVQ	01981BRGS	20
74,0	90,0	10,0	BRAG	AH	FPM	05075BRAGF	20	85,0	105,0	12,0	BRG	AH	FPM	02283BRGF	20
74,0	114,0	11,0	B	LI	NBR	00573B	20	85,0	110,0	12,0	BR	LI	NBR	01767BR	20
75,0	90,0	10,0	BRG	LI	NBR	02451BRG	20	85,0	110,0	14,0	BAG	LI	NBR	00618BAG	20
75,0	90,0	12,0	BA	LI	NBR	00893BA	20	85,7	114,2	11,2	BRG	LI	NBR	01912BRG	20
75,0	95,0	5,0	BA	LI	NBR	01673BA	20	85,7	114,3	13,0	BRAG	H	FPM	05304BRAGF	20
75,0	95,0	10,0	BR	BI	NBR	02531BR	20	85,7	119,0	12,7	B	LI	NBR	00025B	20
75,0	95,0	10,0	BRAG	BI	FPM	07290BRAGF	20	85,9	104,0	11,0	BRG	AH	FPM	02264BRGF	20
75,0	95,0	13,0	BRG	LI	FPM	02753BRGF	20	86,0	103,0	7,0	BRG	AH	FPM	05783BRGF	20
75,0	95,1	13,0	BR	LI	NBR	00046BR	20	87,3	120,8	14,3	B	LI	NBR	00085B	20
75,0	100,0	10,0	BR	LI	NBR	00609BR	20	88,0	108,0	10,1	BRG	AH	FPM	05254BRGF	20
75,0	100,0	10,0	BRG	BI	FPM	02671BRGF	20	88,0	110,0	13,0	BA	LI	NBR	00737BA	20
75,0	100,0	12,0	BAG	H	MVQ	00269BAGS	20	88,9	126,9	12,7	B	LI	NBR	00642B	20
75,0	100,0	12,0	BR	LI	NBR	00269BR	20	89,0	114,3	12,7	B	LI	NBR	01253B	20
75,0	100,0	13,0	BG	BI	NBR	02226BG	20	89,0	114,3	12,7	BG	LI	NBR	02424BG	20
75,0	105,0	13,0	BR	LI	NBR	01183BR	20	89,0	114,3	11,5	B	LI	NBR	00300B	20

Diámetro Eixo	Diámetro Alojamento	Altura Retentor	Tipo	Orien-tación	Material Lábío	Nº SABO	Página
90,0	104,0	11,0	BRAG	AH	FPM	0290BRAGF	20
90,0	110,0	9,0	BRG	AH	FPM	05420BRGF	20
90,0	110,0	12,0	BR	BI	NBR	02574BR	20
90,0	110,0	13,0	BRG	HO	MVQ	05509BRGP	20
90,0	110,1	13,0	BAG	LI	NBR	01416BAG	20
90,0	112,7	13,0	B	LI	NBR	01829B	20
90,0	115,0	13,0	BRG	AH	ACM	02325BRGP	20
90,0	120,0	12,0	BAG	BI	ACM	02208BAGP	20
90,0	120,0	13,0	BRG	LI	NBR	00497BRG	20
91,0	111,0	10,0	BRAG	AH	FPM	02629BRAGF	20
92,0	126,9	12,7	B	LI	NBR	00366B	20
92,1	107,7	10,0	BRG	AH	FPM	02604BRGF	20
92,1	124,0	15,8	BR	LI	NBR	00442BR	20
94,9	115,0	10	BRG	AH	FPM	05091BRGF	20
95,0	115,0	13,0	BRG	BI	NBR	02690BRG	20
95,0	115,0	13,0	BRAG	BI	NBR	02938BRAG	20
95,0	115,0	13,0	BRAG	BI	FPM	07291BRAGF	20
95,0	125,0	13	B	LI	NBR	00045B	20
95,0	130,0	13,0	B	LI	NBR	01043B	20
95,3	114,3	12,0	BG	AH	ACM	02125BGP	20
95,3	120,6	12,7	B	LI	NBR	01257B	20
98,4	126,9	12,0	B	LI	NBR	02213B	20
98,5	144,5	19,0	B	LI	NBR	00007B	20
99,9	130,0	12,0	BR	LI	NBR	01721BR	20
100,0	120,0	13,0	BG	BI	NBR	02049BG	20
100,0	120,0	11,0	BR	LI	NBR	01375BR	20
100,0	123,8	13,0	B	LI	NBR	01801B	20
100,0	125,0	12,0	BR	LI	NBR	01549BR	20
100,0	125,0	12,0	BRA	LI	NBR	01549BRA	20
100,0	130,0	12,0	BRG	LI	ACM	01721BRGP	20
100,0	130,0	13,0	BA	LI	NBR	00043BA	20
100,0	130,0	13,0	BRG	LI	NBR	01974BRG	20
101,6	125,0	13,0	BRG	AH	FPM	05421BRGF	20
101,6	126,9	12,7	B	LI	NBR	00123B	20
102,0	130,0	13,0	BR	LI	NBR	00616BR	20
105,0	130,0	12,0	BRAG	H	FPM	02696BRAGF	20
105,0	130,0	12,0	BRAG	AH	FPM	07840BRAGF	20
105,0	130,0	13,0	B	LI	NBR	00491B	20
105,0	135,0	15,0	BRG	LI	NBR	01774BRG	20
105,0	140,0	12,0	BR	BI	NBR	02195BR	20
108,0	133,3	9,5	B	LI	NBR	01103B	20
108,0	133,3	12,0	B	LI	NBR	00536B	20
108,0	133,4	12,0	BG	BI	NBR	02386BG	20
108,0	136,5	12,7	B	LI	NBR	01468B	20
110,0	130,0	13,0	BAG	LI	NBR	00803BAG	20
110,0	130,0	13,0	BRG	AH	MVQ	00803BRGS	20
110,0	140,0	13,0	BG	BI	NBR	00516BG	20
110,3	133,3	12,0	B	LI	NBR	01739B	20
112,5	130,0	11,0	BRAG	AH	FPM	02619BRAGF	20

Diámetro Eixo	Diámetro Alojamento	Altura Retentor	Tipo	Orien-tación	Material Lábío	Nº SABO	Página
114,3	139,7	12,7	B	LI	NBR	02214B	20
114,3	139,7	14,3	B	LI	NBR	00125B	20
114,3	152,4	12,7	B	LI	NBR	01412B	20
114,3	155,6	14,0	BG	BI	NBR	02180BG	20
115,0	140,0	13,0	BR	LI	NBR	00514BR	20
117,4	142,9	12,5	BR	LI	FPM	07461BRF	20
117,4	142,9	12,5	BR	LI	NBR	07312BR	20
118,0	140,0	13,0	B	LI	NBR	01770B	20
119,0	162,1	15,0	BR	LI	NBR	00546BR	20
120,0	140,0	13,0	BA	AH	ACM	00688BAP	20
120,0	140,0	13,0	BRAG	AH	FPM	02697BRAGF	20
120,0	140,2	13,0	BAG	H	ACM	01885BAGP	20
120,0	145,0	15,0	BRAG	BI	NBR	01884BRAG	20
120,0	145,0	15,0	BRAG	BI	FPM	07319BRAGF	20
120,7	146,1	12,5	BR	LI	NBR	00250BR	20
122,2	140,8	11,8	BRG	AH	MVQ	02115BRGS	20
122,2	140,8	12,0	BRG	AH	FPM	02449BRGF	20
125,0	150,0	13,0	BRG	BI	NBR	02868BRG	20
125,0	150,0	15,0	BG	LI	NBR	01735BG	20
125,0	150,0	15,0	BRAG	BI	NBR	02941BRAG	20
125,0	150,0	15,0	BRAG	BI	FPM	02941BRAGF	20
125,0	150,1	13,0	BR	LI	NBR	00420BR	20
125,0	160,0	12,0	BR	LI	NBR	00780BR	20
127,0	158,7	12,7	B	LI	NBR	00309B	20
127,0	165,1	16,0	B	LI	NBR	00310B	20
130,0	160,0	12,0	BR	LI	NBR	01193BR	20
130,0	160,0	14,0	BRG	AH	FPM	05578BRGF	20
130,0	160,0	15,0	BRG	AH	MVQ	02069BRGS	20
130,4	160,0	12,0	BRAG	AH	FPM	02872BRAGF	20
133,3	158,8	13,0	BRG	AH	FPM	02583BRGF	20
133,4	155,6	14,0	BAG	BI	NBR	02245BAG	20
133,4	165,1	15,9	B	H	NBR	01362B	20
135,0	190,0	15,0	BR	LI	NBR	00042BR	20
140,0	165,0	15,0	BAG	AH	FPM	02185BAGF	20
140,0	170,0	13,0	BR	LI	NBR	00502BR	20
140,0	180,0	15,0	B	LI	NBR	02223B	20
142,9	171,1	14,3	BR	LI	NBR	00248BR	20
145,0	175,0	13,0	B	BI	FPM	02293BF	20
145,0	175,0	13,0	B	BI	NBR	02778B	20
145,0	175,0	14,0	BRG	LI	NBR	02679BRG	20
146,0	168,3	16,0	B	H	NBR	01928B	20
150,0	180,0	13,0	BR	H	ACM	01910BRP	20
150,0	180,0	13,0	BR	H	MVQ	01910BRS	20
150,0	180,0	15,0	BR	LI	NBR	01424BR	20
150,0	180,0	15,0	BRG	LI	NBR	02933BRG	20
150,8	177,8	12,5	BRG	LI	NBR	02093BRG	20
155,0	180,0	15,0	BRAG	AH	FPM	05414BRAGF	20
160,0	200,0	12,0	BR	LI	NBR	01951BR	20
165,0	190,0	12,9	BR	LI	NBR	00160BR	20

**TIPOS BÁSICOS**

<b>Diâmetro Eixo</b>	<b>Diâmetro Alojamento</b>	<b>Altura Retentor</b>	<b>Tipo</b>	<b>Orien- tação</b>	<b>Material Lábio</b>	<b>Nº SABÓ</b>	<b>Página</b>
165,1	193,7	15,7	B	LI	NBR	<b>01976B</b>	20
168,0	188,0	31,5	BAG	BI	NBR	<b>02246BAG</b>	20
168,0	188,0	31,5	BAG	BI	FPM	<b>02246BAGF</b>	20
174,6	200,0	16,0	B	LI	NBR	<b>02138B</b>	20
180,0	205,0	15,0	BRAG	AH	FPM	<b>05725BRAGF</b>	20
185,0	210,0	13,0	BR	LI	NBR	<b>01676BR</b>	20
190,0	220,0	14,8	BR	LI	NBR	<b>00268BR</b>	20

## RETENORES ALTERNATIVOS

Diâmetro Eixo	Diâmetro Alojamento	Altura Retentor	Tipo	Orien-tação	Material Lábio	Nº SABÓ	Pág.
9,0	16,0	9/15,0	GAE	LI	NBR	01662GAE	45
14,0	20,0	2,5	GAG	LI	NBR	02534GAG	45
14,2	28,6	13,5	GAG	LI	NBR	02576GAG	45
15,0	24,0	6,0	GRG (225)	LI	HNBR	07002GRGH	45
15,0	35,0	10,0/12,7	GAO (244)	LI	NBR	01889GAO	45
15,9	28,6	9,5	BRO	LI	NBR	00156BRO	45
16,5	25,0	5,0	GRG	LI	NBR	02876GRG	45
17,0	28,0	7/10	BRGE (194)	H	NBR	01837BRGE	45
17,0	30,0	7,0	BRO	LI	FPM	02963BROF	45
18,7	34,9	8,7	BGO	LI	NBR	00745BGO	44
20,0	30,0	4,0	GRE	LI	NBR	03003GRE	45
20,0	30,0	4,0/7,0	BAO	LI	NBR	01566BAO	44
20,0	32,3	10,0	BRGO	LI	NBR	02408BRGO	45
20,0	35,0	7,0/10,6	BRE (192)	H	ACM	02075BREP	44
20,0	47,0	10,0/12,7	GAE	LI	NBR	01129GAE	45
20,0	47,0	10,0/12,7	GRO	LI	NBR	01129GRO	45
21,0	37,0	7,0/10,0	BRGGG	LI	NBR	02143BRGGG	45
21,5	48,0	8,4	BRGE (139)	H	ACM	07351BRGEP	45
22,0	34,8	8,0	BGO	LI	NBR	00937BGO	44
22,0	40,0	8,0	BRAGE (185)	H	ACM	03019BRAGEP	44
22,8	40,0	6,5/8	BGE	H	ACM	07137BGE	44
25,0	35,0	7,0	GAE	LI	HNBR	07877GAE	45
25,0	35,0	5,0/7,0	GAE	LI	NBR	02261GAE	45
25,0	47,0	7,0	BRO	LI	NBR	02010BRO	45
25,0	47,0	8,0	GRG	LI	NBR	02241GRG	45
25,4	38,1	6,8/13,5	GAO (118)	LI	NBR	01356GAO	45
25,4	44,5	14,3	BF	LI	NBR/FE	00327BF	44
25,6	42,0	7,0/10,3	BRE (190)	BI	NBR	01765BRGE	44
26,0	34,0	5	GAG (103)	LI	NBR	02259GAG	45
28,0	40,0	8,0	BRO	LI	NBR	02157BRO	45
28,0	52,0	6,0/9,0	BRGE (04)	AH	NBR	02728BRGE	45
29,8	42,3	29,5	GE (52)	LI	NBR	10143GE	45
30,0	40,0	10,0	BRO	LI	NBR	03446BRO	45
30,0	62,9	2,5/20,2	BRGE (40)	LI	NBR	02929BRGE	45
30,0	63,0	15,0	BRGGE (125)	LI	NBR	03260BRGGE	45
30,0	72,0	6,5	BRG	BI	NBR	02672BRG	44
30,0	72,0	10,0	BGO	LI	NBR	01581BGO	44
30,5	38,0	7,9	GRE (219)	LI	NBR	01873GRE	45
31,0	43,0	11,0	BRO	LI	NBR	03249BRO	45
34,0	55,0	11,0/15,0	BAGGG	LI	NBR	02152BAGGG	44
35,0	41,0	6,0	BRE (39)	LI	NBR	07689BRE	44

Diâmetro Eixo	Diâmetro Alojamento	Altura Retentor	Tipo	Orien-tação	Material Lábio	Nº SABÓ	Pág.
35,0	45,2	15/24	BROE	LI	NBR	02336BROE	45
35,0	48,0	11,0	BRO	LI	NBR	03248BRO	45
35,6	50,8	7,8/9,6	GRL	LI	NBR	02528GRL	45
36,6	52,4	8,0	BRAGE (137)	H	FPM	05167BRAGEF	44
37,0	45,0	12	GAE	LI	NBR	02707GAE	45
37,0	50,0	11,0	BRO	LI	NBR	03392BRO	45
38,1	63,5	19,0	BB	LI	NBR	01033BB	44
39,4	60,3	12,7	BRO	LI	NBR	01997BRO	45
39,4	80,3	6,40/11,80	BAGE (239)	H	NBR	01660BAGE	44
40,0	50,0	5,0	GRG	LI	NBR	02469GRG	45
40,0	55,0	6,0	GAG	LI	NBR	07683GAG	45
40,0	55,0	8,8	BRGH (203)	LI	NBR/FPW/NY	02859BRGHF	45
40,0	60,0	10,0/11,5	BRGG	BI	ACM	02741BRGGP	45
40,0	62,0	12,0	BRGGG	LI	NBR	01684BRGGG	45
41,0	54,0	11,0	BRO	LI	NBR	03391BRO	45
41,1	62,1	16,0	BGO	H	NBR	02027BGO	45
44,4	54,0	8,6	BAGE (173)	LI	NBR	01858BAGE	44
45,0	73,1	13,0	BAGG	BI	NBR	02395BAGG	44
46,0	65,5	7/8,5	BAGG	LI	NBR	01764BAGG	44
46,3	66,6	0,8/6,7	BAG (130)	BI	NBR	02305BAG	44
47,0	58,0	7,0	BRGG	LI	NBR	02024BRGG	45
47,7	73,1	17,5	BRAGGG (133)	BI	NBR	07395BRAGGG	45
47,8	60,9	6,4	BAE (161)	LI	NBR	00220BAE	44
48,0	65,0	12,0	BGO	AH	NBR	01840BGO	44
48,0	77,0	7,7	GRE (152)	LI	NBR	07075GRE	45
48,7	58,0	8,5	GAO (244)	LI	NBR	03275GAO	45
49,0	76,0	17,4	GB	LI	NBR	01199GB	45
50,0	65,0	10,0	BRGG	***	FPM	07459BRGGF	45
50,0	68,0	9,0	BRGE (13)	H	FPM	05794BRGE	45
50,8	81,0	11,9	BGO	LI	NBR	00274BGO	45
52,4	76,2	7,9	GAO (216)	LI	NBR	00974GAO	45
54,0	81,1	20,7	BABE (54)	BI	ACM	01933BABEP	44
54,0	81,1	22,9	BAGE (41)	LI	ACM	01008BAGEP	44
57,2	82,5	12,0	BAGG (145)	AH	ACM	07262BAGGP	44
57,5	74,0	8,5	GRGG	LI	NBR	05413GRGG	45
59,9	85,5	17,5	GB	LI	NBR	00556GB	45
60,2	85,7	22,9	BABE	LI	ACM	01007BABEP	44
60,3	85,8	23,8	BBO (180)	LI	NBR	02267BBO	44
60,3	85,8	22,8	BABE (54)	BI	NBR	02090BABE	44

## RETENTORES ALTERNATIVOS

Diâmetro Eixo	Diâmetro Alojamento	Altura Retentor	Tipo	Orientação	Material Lábio	Nº SABO	Pág.
61,5	76,2	7,8	GAGGE	LI	NBR	07425GAGGE	45
62,0	78,0	10,0	BRAGG	AH	FPM	07808BRAGGF	44
62,0	85,0	8,5	BGE	LI	NBR	07688BGE	44
62,0	85,0	11,9	BGO	LI	NBR	00805BGO	44
63,5	82,5	12,7	BAGG	AH	ACM	02991BAGGP	44
63,5	89,9	22,2	BBO	LI	NBR	01125BBO	44
63,5	102,5	7	BAGE (238)	H	FPM	02853BAGEF	44
69,8	95,3	16,0	BGO	LI	NBR	01865BGO	44
70,0	80,0	8,0	GAE	LI	ACM	07923GAEP	45
70,0	90,0	12,7	BAGG	AH	ACM	02961BAGGP	44
72,0	85,5	18,0	BAGE (237)	BI	NBR	07716BAGE	44
73,0	101,6	11,5	BAGG	BI	NBR	00421BAGG	44
73,0	101,7	17,4	GB	LI	NBR	01091GB	45
77,0	98,5	8,5	GRE (128)	LI	NBR	08318GRE	45
80,0	100,0	13,0	BGO	LI	NBR	00504BGO	45
82,5	107,9	11,9	BGO	LI	NBR	00644BGO	45
82,6	107,9	16,0	BBR (183)	LI	NBR	01571BBR	44
82,6	134,6	41,2	BAGE (42)	LI	NBR	02019BAGE	44
86,0	99,0	6,7	GAE (117)	LI	NBR	07686GAE	45
87,3	114,3	22,2	BF	LI	NBR/FE	01791BF	44
88,9	152,4	30,4	BAGE (42)	LI	NBR	02804BAGE	44
88,9	152,4	39,1	BAGE (42)	LI	NBR	02018BAGE	44
92,1	123,9	21,0	BGO	LI	NBR	01251BGO	44
94,7	120,0	12,0	BRO	LI	NBR	02464BRO	45
95,0	115,0	9,5	BRGE (13)	AH	FPM	05796BRGEF	45
101,6	127,0	16,0	GB	LI	NBR	02194GB	45
101,6	139,8	14,3	BGO	LI	NBR	01252BGO	44
101,8	127,1	11,9	BGO	LI	NBR	01901BGO	44
144,5	168,3	15,9	BGO	LI	NBR	00649BGO	44
140,0	164,0	20,0	BGE (135)	BI	FPM	08314BGEF	44
145,0	175,0	17,0	BRAGE (104)	BI	FPM	07959BRAGF	44
155,0	180,0	16/29	BAG(17)	BI	FPM	02219BAGF	44

Diâmetro Eixo	Diâmetro Alojamento	Altura Retentor	Tipo	Orientação	Material Lábio	Nº SABÓ	Pág.
11,8	28,0	5,0/7,5	GAE (87)	LI	HNBR	03202GAE	46
23,3	29,7	1,8/4,3	BRE	LI	FPM	03009BREF	46
24,6	44,5	1,5/7,9	BAE	LI	NBR	01722BAE	46
27,0	42,7	1,2/7,9	BAE	LI	NBR	01724BAE	46
29,8	50,0	10,0/13,5	BAGE	H	ACM	07139BAGEP	46
29,8	50,0	10,0/13,5	BRAGE	H	ACM	07539BRAGEP	46
29,8	52,0	10,0/13,5	BAGE	AH	ACM	07138BAGEP	46
29,8	52,0	10,0/13,5	BRAGE	AH	ACM	07538BRAGEP	46
33,0	50,0	10,0/15,0	BAGE	AH	NBR	01834BAGE	46
35,0	54,0	10,0/15,0	BRAGE	BI	NBR	02370BRAGE	46
38,1	54,1	12,7/16,0	BAGE (102)	AH	ACM	07745BAGEP	46
38,1	60,3	12,7/15,9	BAGE	AH	ACM	07199BAGEP	46
38,1	60,3	12,7/17,7	BAGE	AH	NBR	00049BAGE	46
39,4	80,3	6,4/16,2	BRGE	H	ACM	01898BRGEP	46
39,7	80,2	6,4/15,1	BAE (15)	LI	NBR	00029BAE	46
40,0	75,0	12,0/17,0	BRGE (124)	H	ACM	07696BRGEP	46
42,9	65,0	9,5/15,0	BRGE	BI	NBR	01899BRGE	46
43,3	56,2	15/9	BAGE (115)	H	ACM	01943BAGEP	46
44,2	71,4	10,0/16,5	BAGE	H	NBR	02910BAGE	46
46,0	76,2	9,5/12,7	BRE	LI	NBR	01049BRE	46
47,6	70,7	14,4/16,7	BGOE	LI	NBR	00092BGOE	46
47,6	80,0	13,0/26,0	BAGE	BI	NBR	02209BAGE	46
47,6	80,3	6,5/16,5	BRGE	H	ACM	02201BRGEP	46

Diâmetro Eixo	Diâmetro Alojamento	Altura Retentor	Tipo	Orientação	Material Lábio	Nº SABÓ	Pág.
47,7	73,1	9,5/12,0	BARG (105)	BI	NBR	07701BARG	46
50,0	65,0	9,7/14,0	BAGE	BI	NBR	02442BAGE	46
54,0	79,4	12,7/19,0	BAGE	H	NBR	00436BAGE	46
54,0	79,4	12,7/19,0	BAGE	AH	NBR	02393BAGE	46
54,0	80,0	11,1/16,6	BRGE (12)	BI	NBR	02693BRGE	46
55,0	70,0	6,0/10,3	BRGE (13)	BI	NBR	02392BRGE	46
57,2	82,5	9,5/11,5	BAGE (16)	AH	NBR	02103BAG	46
59,0	79,7	9,7/11,8	GRE	LI	NBR	01932GRE	46
60,2	84,1	8/12,7	GAE (20)	LI	NBR	00474GAE	46
60,3	92,0	12,0/18,5	BAGE	AH	NBR	02417BAGE	46
63,5	83,8	9,0/11,5	BAG	BI	NBR	02211BAG	46
69,8	98,5	11,8/17,7	BAGE	H	NBR	01880BAGE	46
72,0	103,7	9,6/20,5	BE	LI	NBR	00181BE	46
80,0	112,0	12,0/18,0	BAGE	H	NBR	02351BAGE	46
85,7	108,0	7,9/14,6	GAE	LI	NBR	01900GAE	46
88,9	115,4	16,2/19,2	BGE	BI	NBR	02483BGE	46
88,9	123,0	18,7/21,7	BGE	BI	NBR	02484BGE	46
90,0	115,0	4,1/13	BRGE	AH	ACM	02997BRGEP	46
95,0	120,0	15,0	BGE (100)	BI	NBR	07920BGE	46
100,0	128,0	15/25	BE	LI	NBR	01805BE	46
110,0	140,0	13,0	BGE (100)	BI	NBR	07919BGE	46
117,4	157,1	13,5/26,5	BGE	BI	NBR	02134BGE	46
145,0	170,0	15/20,6	BAGE	LI	NBR	07281BAGE	46

Diâmetro Eixo	Diâmetro Alojamento	Altura Retentor	Tipo	Orientação	Material Lábio	Nº SABÓ	Pág.
8,0	14,0	4,0	U (D)	LI	FPM	20202U	47
15,0	21,5	3,2	U (D)	LI	NBR	20083U	47
16,0	27,0	7,5	U (B)	LI	NBR	20175U	47
22,0	32,0	8	U (B)	LI	NBR	02002U	47
36,0	52,0	12,0	U (B)	LI	NBR	20171U	47
41,0	57,0	9,5	U (B)	LI	NBR	20166U	47

## RETENTORES PARA MOVIMENTO AXIAL

Diâmetro Eixo	Diâmetro Alojamento	Altura Retentor	Tipo	Orientação	Material Lábio	Nº SABO	Pág.
15,0	25,0	8,1/19	BAGE	LI	NBR	00344BE	47
15,5	28,0	6/15	BAGE (26)	LI	NBR	02420BAGE	47
16,0	26,0	20,0	BAGE	LI	NBR	02008BAGE	47
26,0	42,0	8,0	GRGG	LI	NBR	02165GRGG	47
27,0	39,0	10,5	BRGE (21)	LI	NBR	02312BRGE	47
28,5	39,8	8	BRGE (21)	LI	NBR	02461BRGE	47
30,0	40,5	10,5	BRGE (21)	LI	NBR	02318BRGE	47
30,0	42,0	8,0	GRGGO	LI	NBR	02023GRGGO	47
35,0	48,0	10,5	BRGE (21)	LI	NBR	02353BRGE	47

## PISTA PARA RETENTORES

Diâmetro Eixo	Diâmetro Alojamento	Altura Retentor	Tipo	Orientação	Material Lábio	Nº SABO	Pág.
50,8	58,0	11,5	MV	LI	PH	01064MV	47
52,4	61,2	11,5	MA	LI	MA	01796MA	47



## RETENTORES PARA HASTE DE VÁLVULAS

Diámetro Eixo	Diámetro Alojamento	Altura Retentor	Tipo	Orientación	Material Lábulo	Nº SABO	Pág.
5,0	7,8	8,0	BRE (101)	LI	FPM	09300BREF	48
5,0	8,5	6,6	NE	LI	FPM	09283NEF	48
5,5	8,5	8,0	BRE (101)	LI	FPM	09301BREF	48
5,5	9,2	8,0	NE (34)	LI	FPM	09266NEF	48
5,5	9,2	7/8	NE (34)	LI	ACM	02307NEP	48
5,5	11,0	28,0	BRE (91)	LI	FPM	09302BREF	48
6,0	8,8	12,2	BRE (101)	LI	FPM	09203BREF	48
6,0	11,0	7,7	BRE (101)	LI	FPM	09303BREF	48
6,0	11,0	17,8	BRE (91)	LI	FPM	09250BREF	48
6,0	12,0	19,4	BRE (91)	LI	FPM	09260BREF	48
7,0	9,8	9,6/10	BRE (101)	LI	FPM	03044BREF	48
7,0	10,9	9,5	BRE (108)	LI	FPM	02919BREF	48
7,0	10,9	6,4/11	BRE (32)	LI	ACM	02382BREP	48
7,0	11,0	10,2	BRE (101)	LI	FPM	09228BREF	48
7,0	11,0	10,2	BRE (101)	LI	FPM	09239BREF	48
7,0	11,0	7	BRE (108)	LI	FPM	02509BREF	48
7,0	11,8	10	BAE	LI	FPM	09261BAEF	48
7,9	14,0	12,6	NO (112)	LI	FPM	09286NOF	48
8,0	10,8	10,3	BRE (108)	LI	FPM	02544BREF	48
8,0	12,0	7,0	BRE (108)	LI	FPM	09284BREF	48
8,0	12,0	11,0	BRE (108)	LI	FPM	02396BREF	48
8,0	12,0	7/11	BRE (101)	LI	FPM	09242BREF	48
8,0	13,0	10	BAE	LI	FPM	09262BAEF	48
8,0	14,0	8	BAE	LI	FPM	09212BAEF	48
8,0	14,1	10,4	BRE (109)	LI	ACM	02097BREP	48
8,0	14,1	13,8/13	BRE (111)	LI	FPM	02400BREF	48
8,0	14,1	7,1/10,4	BRE (113)	LI	ACM	02118BREP	48
8,1	13,0	13,5	BRE (107)	LI	FPM	09224BREF	48
8,5	14,1	13,5	BAE	LI	FPM	09271BAEF	48
8,7	13,5	11,0	BRE (107)	LI	FPM	02927BREF	48
8,8	14,3	11	BRE (107)	LI	FPM	09210BREF	48
9,0	12,0	7,0	BRE (108)	LI	FPM	09237BREF	48
9,0	13,0	10	BAE	LI	FPM	09211BAEF	48
9,0	15,0	14	BAE	LI	ACM	01815BAEP	48
9,0	19,0	15,14	BRE (110)	LI	FPM	09235BREF	48
9,4	15,9	12,6	BRE (107)	LI	FPM	02513BREF	48

Diámetro Eixo	Diámetro Alojamento	Altura Retentor	Tipo	Orientación	Material Lábulo	Nº SABO	Pág.
9,4	16,0	28,1	BRE (91)	LI	FPM	09285BREF	48
9,5	14,3	14,3	N (114)	LI	FPM	02590NF	48
9,5	14,4	9,1/13,2	BRE (111)	LI	FPM	03045BREF	48
10,0	12,8	10,2	BAE	LI	FPM	09282BAEF	48
10,0	15,0	10/14	BAE	LI	ACM	01924BAE	48
10,0	19,0	15,14	BRE (110)	LI	FPM	09236BREF	48
11,0	14,0	10/14	BRE (101)	LI	FPM	09205BREF	48
12,0	16,2	14,2	BRE (107)	LI	FPM	02786BREF	48

## RETENTORES PARA VEDAÇÃO EXTERNA

Diâmetro Eixo	Diâmetro Alojamento	Altura Retentor	Tipo	Orientação	Material Lábio	Nº SABO	Pág.
5,0	30,0	8,0 / 14,0	NXE	LI	NBR	01102NXE	48
8,0	35,0	13	BRXE (35)	LI	NBR	02380BRXE	48
16,0	35,0	12	BRX	LI	NBR	00510BRX	48
20,9	30,1	12	GRXE	LI	NBR	01876GRXE	48
22,0	45,0	12	BRX	LI	NBR	01089BRX	48
40,0	66,0	7,0	GAE	LI	ACM	07781GAEP	48
46,0	65,6	11,1	GRX	LI	NBR	01546GRX	48
52,4	74,7	8,4	GGGX	LI	NBR	02026GGGX	48
57,0	85,0	13	BRX	LI	NBR	02673BRX	48
82,5	114,3	14,3	BAX	LI	NBR	01185BAX	48
143,0	150,0	27	BRXE (251)	LI	NBR	01090BRXE	48

## RETENTORES TAMPÃO

Diâmetro Eixo	Diâmetro Alojamento	Altura Retentor	Tipo	Orientação	Material Lábio	Nº SABO	Pág.
2,0	24,5	14,7	MGE	LI	NBR	10316MGE	49
	27,0	7,0	MR (A)	LI	NBR	10409MR	49
	27,5	7,0	MR (B)	0	NBR	10410MR	49
	28,0	7,0	MR (A)	0	NBR	10411MR	49
	40,0	0,0	MR (C)	***	ACM	07460MRP	49
	68,0	8,5	MR (A)	0	ACM	10415MRP	49

## GRUPO I

## RETENTORES COMPOSTOS EM KITS

Diâmetro Eixo	Diâmetro Alojamento	Altura Retentor	Tipo	Orientação	Material Lábio	Nº SABÓ	Pág.
40,0	62,0	7,4	KIT (sem figura)	H	PTFE	05702KIT	-
44,5	62,0	12,0	KIT (sem figura)	BI	NBR	01095JOGO 2	-
63,5	79,5	8,0	KIT (sem figura)	H	PTFE	05603KIT	-
75,0	93,0	8,0	KIT (sem figura)	H	PTFE	05604KIT	-
114,0	174,4	16	MFBE (sem figura)		ESTAMPADO	01466MFBE	-
130,0	150,0	12,0	KIT (sem figura)	AH	PTFE	05287KIT	-
			KIT (sem figura)			05513KIT	-
			KIT (sem figura)			05518KIT	-

## GRUPO J

## ARRUELA PARA VEDAÇÃO

Diâmetro Eixo	Diâmetro Alojamento	Altura Retentor	Tipo	Orientação	Material Lábio	Nº SABÓ	Pág.
8,7	0,0	0,9/1,6	G (B)	0	NBR	20180G	49

## RETENTORES COM ABA NO EXTERNO

Diâmetro Eixo	Diâmetro Alojamento	Altura Retentor	Tipo	Orientação	Material Lábio	Nº SABÓ	Pág.
15,0	21,0	2/14	BRGE (58)	LI	NBR	02319BRGE	49
22,1	40,0	12,0/17	BRG (123)	H	ACM	00224BRG1P	49
22,1	40,0	12,0/17	BRGE (55)	H	NBR	00224BRGE	49
22,1	40,0	12,0/17	BRGE (55)	H	NBR	00224BRGE1	49
22,3	35,7	3,7/10	BRE	H	MVQ	02132BRES	49
25,0	38,0	10,5/14,5	BRGE (57)	LI	FPM	02797BRGEF	49
33,0	51,9	3/12	BAGE	BI	NBR	01849BAGE	49
35,0	54,9	0,7/14,7	BAGE (61)	BI	NBR	02374BAGE	49
35,0	54,9	9/14,7	BAGE (61)	BI	FPM	02836BAGEF	49
38,0	52,0	2,5/8,5	BRGE	LI	NBR	01850BRGE	49
39,5	54,5	3/16	GRE	LI	NBR	01276GRE	49
40,0	52,0	2,8/8,5	BRGE	LI	NBR	02212BRGE	49
40,1	52,0	2,5/8,5	BRGE	LI	NBR	00904BRGE	49
40,1	52,0	3,5/9	BRGE	LI	NBR	00979BRGE	49
44,0	65,0	2,5/12,2	BRGE	LI	NBR	01918BRGE	49
45,0	58,3	5/18	GRE	LI	NBR	01289GRE	49
46,8	69,8	12,0	BAGGE (60)	H	FPM	07868BAGGEF	49
47,6	68,0	10,4	BAGE (60)	H	ACM	02960BAGEP	49
73,0	98,5	11,0	BAGE (60)	BI	NBR	07552BAGE	49

## GRUPO L

## RETENTORES INTEGRADOS

Diâmetro Eixo	Diâmetro Alojamento	Altura Retentor	Tipo	Orientação	Material Lábio	Nº SABÓ	Pág.
40,0	70,0	7/13	BRABGE	BI	FPM / ACM	07481BRABGE	50
57,2	82,6	0,9/14	BRGE (67)	AH	NBR / ACM	02512BRGEP	50
63,5	98,5	17,9	BRGE (67)	H	ACM	02686BRGEP	50
69,8	98,4	2,5/11,5	BRGE (67)	H	ACM	02562BRGEP	50
76,3	125,4	16,5	BRGE (67)	BI	NBR / ACM	02687BRGEP	50
85,0	145,0	37,0	BRABGE (131)	BI	FPM / NBR	07475BRABGE	50

Diâmetro Eixo	Diâmetro Alojamento	Altura Retentor	Tipo	Orientação	Material Lábio	Nº SABÓ	Pág.
30,0	52,0	10	GY	LI	NBR	02744GY	50
40,0	69,0	15,4	BY	BI	NBR	07630BY	50
70,0	99,0	13,0	BRAY	BI	FPM	07735BRAYF	50
73,0	95,0	9,5	GY	BI	FPM/ NBR	08398GY	50
75,0	100,0	10,0	BRY	LI	NBR	08316BRY	50
82,5	114,3	12,7	BY	BI	NBR	07375BY	50
82,5	114,3	12,7	BY	BI	FPM	07439BYF	50
85,0	105,0	13,0	BRY (68)	H	NBR/ FPM	07982BRYF	50
85,0	105,0	13,0	BRY (68)	AH	NBR/ FPM	07985BRY	50
87,0	110,0	14,5	BRY	BI	FPM/ NBR	08392BRY	50
98,4	144,5	16	BY	BI	NBR	02485BY	50
101,0	131,0	14,0	BRY	BI	FPM/ NBR	08397BRY	50
106,5	140,0	15	BY	BI	NBR	02894BY	50
121,1	160,0	35	BAY	BI	FPM	07340BAYF	50
121,1	160,2	30,0	BRY (68)	BI	NBR	02713BRY	50
121,1	160,2	30,0	BRY (68)	BI	ACM / NBR	08383BRY	50
121,1	160,2	35	BAY	BI	NBR/ FPM	07338BAYF	50
127,0	158,8	16	BY	BI	NBR	02496BY	50
136,8	165,0	13,0	BGY (136)	BI	NBR	07970BGY	50
142,0	170,0	14,0	BY	BI	NBR	07790BY	50
142,8	182,5	24	BY (69)	BI	NBR	02490BY	50

# GRUPO N

## RETENTORES SOMENTE DE BORRACHA

Diâmetro Eixo	Diâmetro Alojamento	Altura Retentor	Tipo	Orientação	Material Lábio	Nº SABÓ	Pág.
7,2	19,3	3,0	G	0	0	20148G	50
16,0	22,0	6,0	U (A)	LI	NBR	20181U	50
17,0	21,5	15,0	NE (74)	LI	FPM	20205NEF	50
19,7	31,8	18,0	GE	LI	NBR	20145GE	50
24,3	39,5	9,2	NEO	LI	NBR	00524NEO	50
50,0	76,0	6	NE	LI	NBR	07074NE	50
157,0	170,3	19,5	UE	LI	NBR	20210UE	50

## RETENTORES FIXADOS POR PARAFUSOS

Diâmetro Eixo	Diâmetro Alojamento	Altura Retentor	Tipo	Orientação	Material Lábio	Nº SABÓ	Pág.
19,0	50,8	1,7/7,7	BAE (79)	LI	FPM	02716BAEF	51
50,8	115,9	14,3	BAGE	LI	NBR	00039BAGE	51
50,8	116,0	16,2	BAGE	LI	NBR	01595BAGE	51
58,0	98,0	12,8	BAGE (80)	LI	NBR	01795BAGE	51
60,3	149,4	8,3	BAE	BI	NBR	02098BAE	51
60,3	155,5	8,0	BAE	BI	NBR	02333BAE	51
60,5	149,4	11,5	BE	LI	NBR	01028BE	51
63,6	155,6	12	BAE	BI	NBR	02033BAE	51
150,8	229,4	28,6	BAGE	BI	NBR	02044BAGE	51

## GRUPO P

## RETENTORES DE METAL E FELTRO

Diâmetro Eixo	Diâmetro Alojamento	Altura Retentor	Tipo	Orientação	Material Lábio	Nº SABÓ	Pág.
60,0	75,0	5	MFE (A)	0	Metal/ Feltro	01821MFE	51

## GRUPO Q

## RETENTORES DE FELTRO

Diâmetro Eixo	Diâmetro Alojamento	Altura Retentor	Tipo	Orientação	Material Lábio	Nº SABÓ	Pág.
23,6	38,1	9,6	GF	0	FELTRO	00287GF	51
26,1	36,1	8	F	0	FELTRO	00757F	51
NA	0,0	0,0	F	0	0	01402F	51

Diâmetro Eixo	Diâmetro Alojamento	Altura Retentor	Tipo	Orientação	Material Lábio	Nº SABÓ	Pág.
17,5	50,4	21,5	SP	LI	ACM	07679SP	52
17,5	50,4	21,5	SP	LI	ACM	07807SP	52
114,0	174,4	16	MFBE	0	ES-TAMPADO	01466MFBE*	52

\*01466MFBE - Conjunto Composto de:

- (1) 01132 GR
- (2) 01632 FE
- (3) 01633 ME

# GRUPO S

### RETENTORES COM LÁBIO DE VEDAÇÃO EM PTFE

Diâmetro Eixo	Diâmetro Alojamento	Altura Retentor	Tipo	Orientação	Material Lábio	Nº SABÓ	Pág.
53,7	67,7	7,0	MEH	LI	PTFE	05545MEH	52
75,0	93,0	8,0	GRAGH	H	PTFE	05536GRAGH	52
78,0	104,0	11,0	GRAH	H	PTFE	05214GRAHF	52
100,0	130,0	12,0	GRAH	H	PTFE	05184GRAHF	52
115,0	140,0	13,0	GRAH	AH	PTFE	05155GRAHF	52
120,0	140,0	13,0	GRAH	H	PTFE	05679GRAGH	52
130,0	150,0	12	GRAGH (148)	AH	PTFE	05287GRAGH	52
145,0	175,0	13,0	GRAH	AH	PTFE	05680GRAHF	52

## SISTEMAS INTEGRADOS DE VEDAÇÃO

Diâmetro Eixo	Diâmetro Alojamento	Altura Retentor	Tipo	Orientação	Material Lábio	Nº SABÓ	Pág.
21,8	35,0	54,9 / 31	BAGE	H	ACM	07240BAGEP	52
21,8	85,0	48,4	BAGE	H	ACM	02952BAGEP	52
39,9	68,9	15,4	SIST.BY	BI	NBR	07300BY	52
64,0	0,0	0,0	FLANGE	AH	FPM	05198SIST	52
70,0	0,0	0,0	FLANGE	H	PTFE / ACM	05652SIST	52
74,0	0,0	0,0	MJEF	AH	FPM	05245MJEF	52
74,0	0,0	0,0	GAHFE	AH	PTFE	05772GAHFE	52
79,0	-	21,0	PHSI	AH	PTFE	05338PHSI	52
85,0	0,0	0,0	IOSS	AH	PTFE	05699IOSS	52
85,0	0,0	0,0	IOSS	AH	PTFE	05801IOSS	52
85,0	-	13,0	GHSI	AH	PTFE	05502GHSI	52
93,0	0,0	0,0	BSI	AH	FPM	05813BSI	52
99,5	108,0	19,0	GHSIF	AH	PTFE	05239GHSIF	52
114,0	0,0	0,0	FLANGE	AH	PTFE / ACM	05651SIST	52

## GRUPO U

## RETENTORES TIPO "S"

Diâmetro Eixo	Diâmetro Alojamento	Altura Retentor	Tipo	Orientação	Material Lábio	Nº SABÓ	Pág.
14,2	50,7	46,1	S (150)	LI	NBR	02020S	53











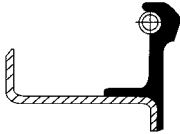
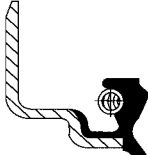
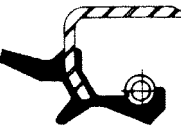

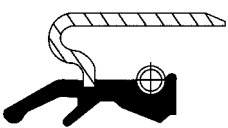
**GRUPO A**

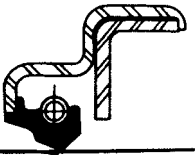
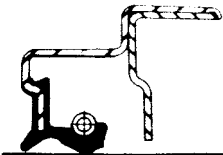
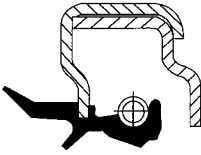
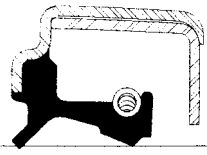
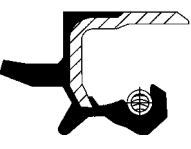
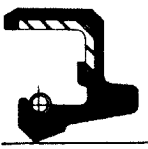
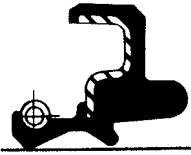
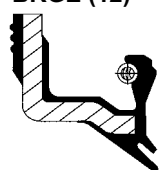
<b>BABE</b> 	<b>BABE (54)</b> 	<b>BAE (161)</b> 	<b>BAG (17)</b> 
<b>BAG (130)</b> 	<b>BAGE (41)</b> 	<b>BAGE (42)</b> 	<b>BAGE (173)</b> 
<b>BAGE (237)</b> 	<b>BAGE (238)</b> 	<b>BAGE (239)</b> 	<b>BAGG</b> 
<b>BAGG (145)</b> 	<b>BAGGG</b> 	<b>BAO</b> 	<b>BB</b> 
<b>BBO</b> 	<b>BBO (180)</b> 	<b>BBR (183)</b> 	<b>BF</b> 
<b>BGE</b> 	<b>BGE (135)</b> 	<b>BGO</b> 	<b>BRAGE (104)</b> 
<b>BRAGE (137)</b> 	<b>BRAGE (185)</b> 	<b>BRAGG</b> 	<b>BRAGGG (133)</b> 
<b>BRE (39)</b> 	<b>BRE (190)</b> 	<b>BRE (192)</b> 	<b>BRG</b> 

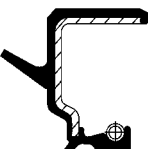
**DESENHOS TÉCNICOS**

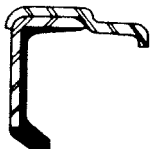
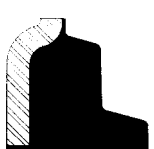
BRGE (04) 	BRGE (13) 	BRGE (40) 	BRGE (139) 
BRGE (194) 	BRGG 	BRGGE (125) 	BRGGG 
BRGH (203) 	BRGO 	BRO 	BROE 
GAE 	GAE (117) 	GAG 	GAG (103) 
GAGGE 	GAO (118) 	GAO (216) 	GAO (244) 
GB 	GE (52) 	GRE 	GRE (128) 
GRE (152) 	GRE (219) 	GRG 	GRG (225) 
GRGG 	GRL 	GRO 	

<p><b>BAE</b></p> 	<p><b>BAE (15)</b></p> 	<p><b>BAG</b></p> 	<p><b>BAGE</b></p> 
<p><b>BAGE (16)</b></p> 	<p><b>BAGE (102)</b></p> 	<p><b>BAGE (115)</b></p> 	<p><b>BARG (105)</b></p> 
<p><b>BE</b></p> 	<p><b>BGE</b></p> 	<p><b>BGE (100)</b></p> 	<p><b>BGOE</b></p> 
<p><b>BRAGE</b></p> 	<p><b>BRE</b></p> 	<p><b>BRGE</b></p> 	<p><b>BRGE (12)</b></p> 
<p><b>BRGE (13)</b></p> 	<p><b>BRGE (124)</b></p> 	<p><b>GAE</b></p> 	<p><b>GAE (20)</b></p> 
<p><b>GAE (87)</b></p> 	<p><b>GRE</b></p> 		

**DESENHOS TÉCNICOS**











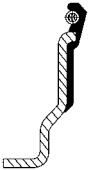

<p>U (B)</p>	<p>U (D)</p>		
--------------	--------------	--	--

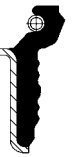





**DESENHOS TÉCNICOS**

<p>BAGE</p>	<p>BAGE (26)</p>	<p>BRGE (21)</p>	<p>GRGG</p>
<p>GRGGO</p>			

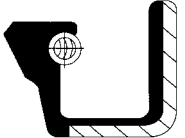

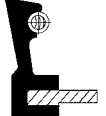
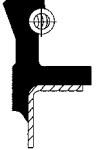
**DESENHOS TÉCNICOS**

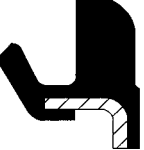
<p>M (A)</p>	<p>M (V)</p>		
--------------	--------------	--	--

BAE 	BRE (32) 	BRE (91) 	BRE (101) 
BRE (107) 	BRE (108) 	BRE (109) 	BRE (110) 
BRE (111) 	BRE (113) 	N (114) 	NE 
NE (34) 	NO (112) 		

BAX 	BRX 	BRXE (35) 	BRXE (251) 
GAE 	GGGX 	GRX 	GRXE 
NXE 			

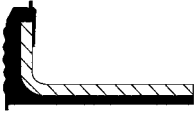

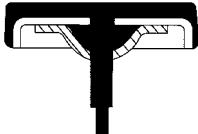



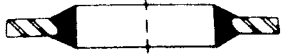

DESENHOS TÉCNICOS

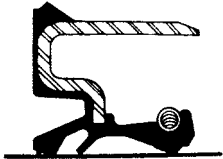
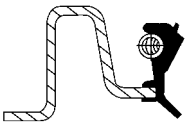
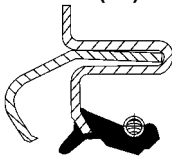
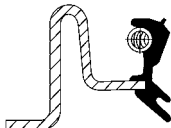
<p>MR (C)</p> 	<p>MR (A)</p> 	<p>MR (B)</p> 	<p>MGE</p> 
---	---	--	--

DESENHOS TÉCNICOS

<p>G (B)</p> 			
--	--	--	--

DESENHOS TÉCNICOS

<p>BAGE</p> 	<p>BAGE (60)</p> 	<p>BAGE (61)</p> 	<p>BAGGE (60)</p> 
<p>BRE</p> 	<p>BRG (123)</p> 	<p>BRGE</p> 	<p>BRGE (55)</p> 
<p>BRGE (57)</p> 	<p>BRGE (58)</p> 	<p>GRE</p> 	



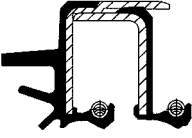
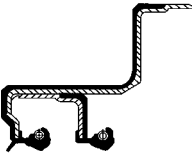
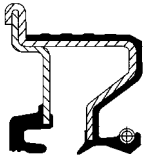

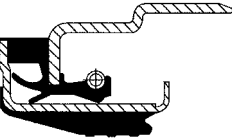
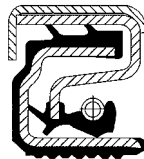
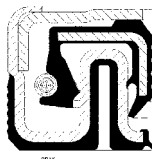
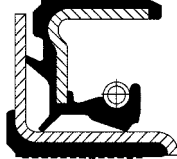
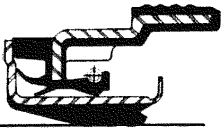
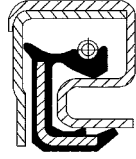
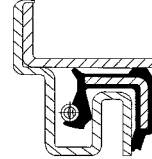
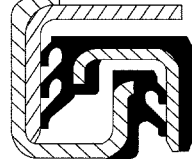

# GRUPO L

<b>BRABGE</b> 	<b>BRABGE (131)</b> 	<b>BRGE (67)</b> 	
--	--	--	--







# GRUPO M

<b>BAY</b> 	<b>BGY (136)</b> 	<b>BRAY</b> 	<b>BRY</b> 
<b>BRY (68)</b> 	<b>BY</b> 	<b>BY (69)</b> 	<b>GY</b> 

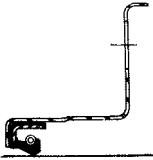
# GRUPO N

<b>G</b> 	<b>GE</b> 	<b>NE</b> 	<b>NE (74)</b> 
<b>NEO</b> 	<b>U (A)</b> 	<b>UE</b> 	

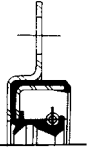

**DESENHOS TÉCNICOS**

<p><b>BAE</b></p> 	<p><b>BAE</b></p> 	<p><b>BAE (79)</b></p> 	<p><b>BAGE</b></p> 
<p><b>BAGE (80)</b></p> 	<p><b>BE</b></p> 		

**DESENHOS TÉCNICOS**

<p><b>MFE (A)</b></p> 			
---	--	--	--

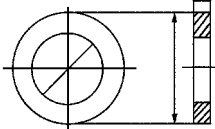
**DESENHOS TÉCNICOS**

<p><b>F</b></p> 	<p><b>GF</b></p> 		
---	--	--	--





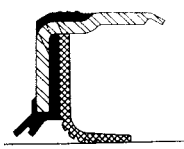
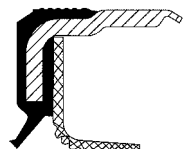
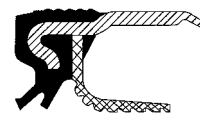
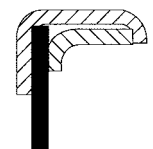

# GRUPO R

<p>SP</p> 			
---	--	--	--

# GRUPO S

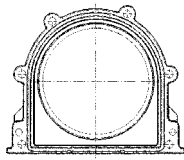
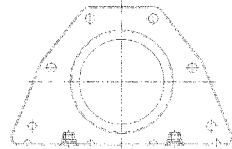
<p>GRAGH</p> 	<p>GRAGH (148)</p> 	<p>GRAH</p> 	<p>MEH</p> 
--	--	--	--

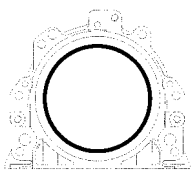
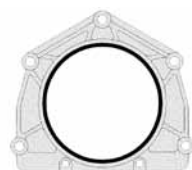
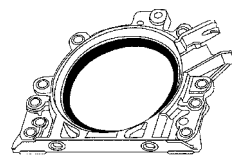
# GRUPO T

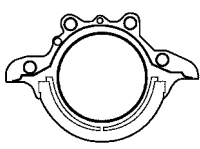
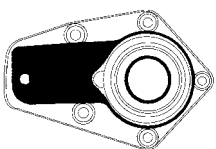
<p>BAGE</p> 	<p>BSI</p> 	<p>FLANGE</p> 	<p>GAHFE</p> 
<p>GHSI</p> 	<p>GHSIF</p> 	<p>IOSS</p> 	<p>MJEF</p> 
<p>PHSI</p> 	<p>SIST.BY</p> 		

<p>S (150)</p> 			
--	--	--	--

Nº SABÓ	Tipo	Diám. Eixo	Diám. Alojamento	Altura Retentor	Orientação	Material Lábio	Grupo
00002B	B	81	117,5	14,3	LI	NBR	TB
00005B	B	52,4	81	11,5	LI	NBR	TB
00006BA	BA	53,8	77,7	12,7	LI	NBR	TB
00007B	B	98,5	144,5	19	LI	NBR	TB
00013B	B	57,3	76,2	12,7	LI	NBR	TB
00013BRG	BRG	57,3	76,2	12,7	LI	NBR	TB
00016B	B	39,7	61,2	12,7	LI	NBR	TB
00017B	B	31,8	42,8	9,5	LI	NBR	TB
00019BR	BR	38,1	63,5	12,7	LI	NBR	TB
00025B	B	85,7	119	12,7	LI	NBR	TB
00028B	B	31,7	50,7	11	LI	NBR	TB
00029BAE	BAE(15)	39,7	80,2	6,4/15,1	LI	NBR	B
00030B	B	66,7	92	12	LI	NBR	TB
00037B	B	53,9	73	12,7	LI	NBR	TB
00039BAGE	BAGE	50,8	115,9	14,3	LI	NBR	O
00042BR	BR	135	190	15	LI	NBR	TB
00043BA	BA	100	130	13	LI	NBR	TB
00044BR	BR	62	85	13	LI	NBR	TB
00045B	B	95	125	13	LI	NBR	TB
00046BR	BR	75	95,1	13	LI	NBR	TB
00047B	B	52	72	12	LI	NBR	TB
00047BAGF	BAG	52	72	12	LI	FPM	TB
00048BR	BR	50,8	76,3	12,7	LI	NBR	TB
00049B	B	38,1	60,3	12,7	LI	NBR	TB
00049BAG	BAG	38,1	60,3	12,7	AH	NBR	TB
00049BAGE	BAGE	38,1	60,3	12,7/17,7	AH	NBR	B
00051BR	BR	65	90	10	LI	NBR	TB
00054BR	BR	28,6	39,7	9,5	LI	NBR	TB
00063BRG	BRG	45	62	10	LI	NBR	TB
00069B	B	44,5	69,8	12,7	LI	NBR	TB
00070BA	BA	58,7	85	8	LI	NBR	TB
00072BA	BA	49,2	69,9	9,5	LI	NBR	TB
00081B	B	69,9	98,5	12,7	LI	NBR	TB
00085B	B	87,3	120,8	14,3	LI	NBR	TB
00087B	B	72,2	100	12,7	LI	NBR	TB
00092BGOE	BGOE	47,6	70,7	14,4/16,7	LI	NBR	B
00098B	B	73	95,2	12,7	LI	NBR	TB
00109B	B	57,2	81	12,7	LI	NBR	TB
00114GR	GR	31,7	42,9	5	LI	NBR	TB
00116B	B	73	101,6	12,7	LI	NBR	TB
00117GR	GR	28,6	39,8	4,7	LI	NBR	TB
00118BAG	BAG	22	35	10	LI	NBR	TB
00120BAG	BAG	63,5	88,9	12,7	LI	NBR	TB
00121BA	BA	27	42,9	7,1	LI	NBR	TB
00123B	B	101,6	126,9	12,7	LI	NBR	TB
00125B	B	114,3	139,7	14,3	LI	NBR	TB
00128BR	BR	44,5	66,7	12,7	LI	NBR	TB
00129BR	BR	12,7	25,4	9,5	LI	NBR	TB
00131BR	BR	30	47	10	LI	NBR	TB

Nº SABÓ	Tipo	Diám. Eixo	Diám. Alojamento	Altura Retentor	Orientação	Material Lábio	Grupo
00133BR	BR	41,3	63,6	12,7	LI	NBR	TB
00136BA	BA	35	62	12	LI	NBR	TB
00141BA	BA	25,4	38,1	10	LI	NBR	TB
00145B	B	25,4	46,6	9,5	LI	NBR	TB
00146B	B	57,2	79,3	12,7	LI	NBR	TB
00155B	B	47,6	69,8	12,7	LI	NBR	TB
00156B	B	15,9	28,6	9,5	LI	NBR	TB
00156BRO	BRO	15,9	28,6	9,5	LI	NBR	A
00159BR	BR	19	35	10	LI	NBR	TB
00160BR	BR	165	190	12,9	LI	NBR	TB
00161BRG	BRG	48	72	10	LI	NBR	TB
00162BR	BR	50	71,9	12	LI	NBR	TB
00164BAG	BAG	65	90	13	LI	NBR	TB
00164BR	BR	65	90	13	LI	NBR	TB
00181BE	BE	72	103,7	9,6/20,5	LI	NBR	B
00188BA	BA	57,3	84	8	LI	NBR	TB
00191BR	BR	25	41,1	9,5	LI	NBR	TB
00214BR	BR	35	54	11	LI	NBR	TB
00218B	B	36,5	57,1	12,7	LI	NBR	TB
00219BR	BR	44	76,1	12,7	LI	NBR	TB
00220BAE	BAE (161)	47,8	60,9	6,4	LI	NBR	A
00221B	B	79,4	104,7	12,7	LI	NBR	TB
00222BAG	BAG	44,7	61,2	9,5	H	NBR	TB
00223BR	BR	60	80	10	AH	NBR	TB
00224BRG1P	BRG (123)	22,1	40	12,0/17	H	ACM	K
00224BRGE	BRGE (55)	22,1	40	12,0/17	H	NBR	K
00224BRGE1	BRGE (55)	22,1	40	12,0/17	H	NBR	K
00228BAG	BAG	68	90	10	LI	NBR	TB
00229B	B	49,2	80,9	11	LI	NBR	TB
00231BRG	BRG	53,9	81,1	12	LI	NBR	TB
00248BR	BR	142,9	171,1	14,3	LI	NBR	TB
00250BR	BR	120,7	146,1	12,5	LI	NBR	TB
00258GA	GA	35	57,9	6,4	LI	NBR	TB
00262B	B	28	47	10	LI	NBR	TB
00262BA	BA	28	47	10	LI	NBR	TB
00266BR	BR	25	47	10	LI	NBR	TB
00268BR	BR	190	220	14,8	LI	NBR	TB
00269BAGS	BAG	75	100	12	H	MVQ	TB
00269BR	BR	75	100	12	LI	NBR	TB
00272BRG	BRG	45	60	7	LI	NBR	TB
00274BGO	BGO	50,8	81	11,9	LI	NBR	A
00276B	B	44,5	73	12	LI	NBR	TB
00283BR	BR	25,4	36,4	6,4	LI	NBR	TB
00284BR	BR	35	55,5	6,4	LI	NBR	TB
00285BA	BA	27	38,1	6,4	LI	NBR	TB
00286BR	BR	15,9	25,4	4,5	LI	NBR	TB
00287GF	GF	23,6	38,1	9,6	0	FELTRO	Q
00288BR	BR	42	56	7	LI	NBR	TB
00289BA	BA	12	22	7	LI	NBR	TB

Nº SABÓ	Tipo	Diâm. Eixo	Diâm. Alojamento	Altura Retentor	Orientação	Material Lábio	Grupo	Nº SABÓ	Tipo	Diâm. Eixo	Diâm. Alojamento	Altura Retentor	Orientação	Material Lábio	Grupo
00291B	B	49,2	76,1	12,7	LI	NBR	TB	00492BA	BA	35	56,1	12	LI	NBR	TB
00291BR	BR	49,2	76,1	12,7	LI	NBR	TB	00495BA	BA	32	45	7	LI	NBR	TB
00293BR	BR	14,3	28,5	6,4	LI	NBR	TB	00496BRG	BRG	18	30	7	LI	NBR	TB
00294BR	BR	22	35	6,7	LI	NBR	TB	00497BRG	BRG	90	120	13	LI	NBR	TB
00300B	B	89	114,3	11,5	LI	NBR	TB	00498BR	BR	55	80	13	LI	NBR	TB
00302B	B	46	62	7	LI	NBR	TB	00499BR	BR	25	50,1	10	LI	NBR	TB
00305BAG	BAG	60	78,1	8,8	LI	NBR	TB	00500BAG	BAG	68	90	13	H	FPM	TB
00309B	B	127	158,7	12,7	LI	NBR	TB	00500BAGF	BAG	68	90	13	H	FPM	TB
00310B	B	127	165,1	16	LI	NBR	TB	00500BAGP	BAG	68	90	13	H	ACM	TB
00321BA	BA	57,2	82,5	12,7	LI	NBR	TB	00501BR	BR	60	75	8	LI	NBR	TB
00327BF	BF	25,4	44,5	14,3	LI	NBR/FE	A	00502BR	BR	140	170	13	LI	NBR	TB
00329BA	BA	19	28,5	6,4	LI	NBR	TB	00503BR	BR	28	52,1	10	LI	NBR	TB
00334BAG	BAG	60,3	92	12	H	NBR	TB	00504BGO	BGO	80	100	13	LI	NBR	A
00343BR	BR	31,7	44,5	8	LI	NBR	TB	00505BR	BR	20	30	7	LI	NBR	TB
00344BE	BAGE	15	25	8,1/19	LI	NBR	D	00506BR	BR	25	43,1	10	LI	NBR	TB
00357B	B	76,2	101,7	12	LI	NBR	TB	00508BA	BA	17	28	7	LI	NBR	TB
00357BA	BA	76,2	101,7	12	LI	NBR	TB	00508BAG	BA	17	28	7	LI	NBR	TB
00358BR	BR	30	50	10	LI	NBR	TB	00509BR	BR	45	72	12	LI	NBR	TB
00359BR	BR	45	65	10	LI	NBR	TB	00510BRX	BRX	16	35	12	LI	NBR	G
00360BA	BA	20	40	10	LI	NBR	TB	00514BR	BR	115	140	13	LI	NBR	TB
00366B	B	92	126,9	12,7	LI	NBR	TB	00515GA	GA	15	30	5	LI	NBR	TB
00369BR	BR	66,7	88,9	12,7	LI	NBR	TB	00516BG	BG	110	140	13	BI	NBR	TB
00371B	B	60,3	85	12	LI	NBR	TB	00517BR	BR	60	90	10	LI	NBR	TB
00373GA	GA	39,1	62,2	6,4	LI	NBR	TB	00520BR	BR	35	47,1	10	LI	NBR	TB
00375BA	BA	15,9	35	10	LI	NBR	TB	00521BR	BR	42	62,1	10	LI	NBR	TB
00376B	B	69,8	95,2	12,7	LI	NBR	TB	00522BRG	BRG	48	72,1	7	LI	NBR	TB
00378B	B	63,5	89,9	12	LI	NBR	TB	00524NEO	NEO	24,3	39,5	9,2	LI	NBR	N
00379BR	BR	66,7	95,3	12,7	LI	NBR	TB	00527B	B	48	65	10	LI	NBR	TB
00405B	B	47,6	66,6	12,7	LI	NBR	TB	00536B	B	108	133,3	12	LI	NBR	TB
00420BR	BR	125	150,1	13	LI	NBR	TB	00546BR	BR	119	162,1	15	LI	NBR	TB
00421BAGG	BAGG	73	101,6	11,5	BI	NBR	A	00547B	B	59,5	85,6	12	LI	NBR	TB
00423BR	BR	70	100	12	LI	NBR	TB	00554BA	BA	44,5	79,9	11,1	LI	NBR	TB
00434B	B	66,7	112,7	11	LI	NBR	TB	00556GB	GB	59,9	85,5	17,5	LI	NBR	A
00436BAG	BAG	54	79,4	12,7	LI	NBR	TB	00561BAG	BAG	42	64,9	12	LI	NBR	TB
00436BAGE	BAGE	54	79,4	12,7/19,0	H	NBR	B	00563BR	BR	54	72	8	LI	NBR	TB
00442BR	BR	92,1	124	15,8	LI	NBR	TB	00566BA	BA	48	62	8	LI	NBR	TB
00459BR	BR	55	80	10	LI	NBR	TB	00569B	B	19	31,7	6,4	LI	NBR	TB
00460BR	BR	62	85	10	LI	NBR	TB	00569BR	BR	19	31,7	6,4	LI	NBR	TB
00463BR	BR	25	52	10	LI	NBR	TB	00572BR	BR	22,3	35	6,4	LI	NBR	TB
00469B	B	25	40	10	LI	NBR	TB	00573B	B	74	114	11	LI	NBR	TB
00474GAE	GAE (20)	60,2	84,1	8/12,7	LI	NBR	B	00586BR	BR	50,9	69,8	9,5	LI	NBR	TB
00477BA	BA	32	57,1	9,5	LI	NBR	TB	00586BRG	BRG	50,9	69,8	9,5	H	NBR	TB
00479BR	BR	38	52	10	LI	NBR	TB	00593B	B	82	104,7	14,3	LI	NBR	TB
00479BRG	BRG	38	52	10	LI	NBR	TB	00604BR	BR	43	62	10	LI	NBR	TB
00484BA	BA	30	50,1	12	LI	NBR	TB	00609BR	BR	75	100	10	LI	NBR	TB
00485BA	BA	35	47	7	LI	NBR	TB	00610BR	BR	80	100	10	LI	NBR	TB
00486BA	BA	38	50	7	LI	NBR	TB	00612BR	BR	84	110,1	16	LI	NBR	TB
00490BR	BR	70	90	13	LI	NBR	TB	00616BR	BR	102	130	13	LI	NBR	TB
00491B	B	105	130	13	LI	NBR	TB	00618BAG	BAG	85	110	14	LI	NBR	TB

Nº SABÓ	Tipo	Diám. Eixo	Diám. Alojamento	Altura Retentor	Orientação	Material Lábio	Grupo
00620B	B	55	75	12	LI	NBR	TB
00630B	B	50,8	73	12,7	LI	NBR	TB
00634BAG	BAG	28,6	44,5	11	LI	NBR	TB
00642B	B	88,9	126,9	12,7	LI	NBR	TB
00644B	B	82,5	107,9	11,9	LI	NBR	TB
00644BGO	BGO	82,5	107,9	11,9	LI	NBR	A
00649BGO	BGO	136,5	168,3	15,9	LI	NBR	A
00652BG	BG	63,5	88,9	17,8	LI	NBR	TB
00660B	B	50,8	80	12,7	LI	NBR	TB
00674B	B	47,7	73	12	LI	NBR	TB
00688BAP	BA	120	140	13	AH	ACM	TB
00694B	B	35	53,9	9,5	LI	NBR	TB
00701B	B	30	50,8	11	LI	NBR	TB
00708BR	BR	49,2	65	8	LI	NBR	TB
00709BR	BR	25	44,9	5	LI	NBR	TB
00712BR	BR	20	32	6	LI	NBR	TB
00713GA	GA	28	34,9	5	LI	NBR	TB
00715BA	BA	20	35	6	LI	NBR	TB
00726BR	BR	16,3	24	7	LI	NBR	TB
00734BR	BR	44,5	57,2	9,4	LI	NBR	TB
00735B	B	57,1	80	13	LI	NBR	TB
00737BA	BA	88	110	13	LI	NBR	TB
00745BGO	BGO	18,7	34,9	8,7	LI	NBR	A
00749BA	BA	44,5	54	4,8	LI	NBR	TB
00752BA	BA	50,8	79,9	10	LI	NBR	TB
00757F	F	26,1	36,1	8	0	FELTRO	Q
00758BR	BR	35	52,1	12	LI	NBR	TB
00760BR	BR	20	35	10	LI	NBR	TB
00761BR	BR	22	40	7	LI	NBR	TB
00762BR	BR	31	47	7	LI	NBR	TB
00763BR	BR	24	47	7	LI	NBR	TB
00764BA	BA	10	30	7	LI	NBR	TB
00769BA	BA	22	31,9	5	LI	NBR	TB
00770B	B	25	62	10	LI	NBR	TB
00771BA	BA	28,5	50,7	10	LI	NBR	TB
00772BA	BA	30	55	12	LI	NBR	TB
00774B	B	31,7	50,8	9,5	LI	NBR	TB
00775BA	BA	44	79,9	12	LI	NBR	TB
00780BR	BR	125	160	12	LI	NBR	TB
00784BR1	BR	19	35	7	LI	NBR	TB
00788BAG	BAG	25	35	10	LI	NBR	TB
00789BA	BA	35	50	10	LI	NBR	TB
00789BR	BR	35	50	10	LI	NBR	TB
00790BR	BR	15	24	7	LI	NBR	TB
00793BA	BA	55	90	10	LI	NBR	TB
00795BR	BR	16	30	10	LI	NBR	TB
00796BR	BR	16	32	7	LI	NBR	TB
00797BA	BA	36	54	7	LI	NBR	TB

Nº SABÓ	Tipo	Diám. Eixo	Diám. Alojamento	Altura Retentor	Orientação	Material Lábio	Grupo
00797BR	BR	36	54	7	LI	NBR	TB
00798BA	BA	19	31,9	7	LI	NBR	TB
00800BA	BA	35	62	9,5	LI	NBR	TB
00801BR	BR	32	52,1	10	LI	NBR	TB
00803BAG	BAG	110	130	13	LI	NBR	TB
00803BRGS	BRG	110	130	13	AH	MVQ	TB
00804BR	BR	55	75	10	LI	NBR	TB
00805BGO	BGO	62	85	11,9	LI	NBR	A
00810BA	BA	30	40	8	LI	NBR	TB
00813BA	BA	30	43	9,5	LI	NBR	TB
00813BAG	BAG	30	43	9,5	LI	NBR	TB
00815BR	BR	22	42	10	LI	NBR	TB
00817BR	BR	30	56	12	LI	NBR	TB
00818BR	BR	60	80	13	LI	NBR	TB
00819BR	BR	78	110	13	LI	NBR	TB
00821BR	BR	19	31,8	6,4	LI	NBR	TB
00822BA	BA	35,0	45,0	7,0	LI	NBR	TB
00829BR	BR	24	38	9	LI	NBR	TB
00832BR	BR	30	45	12	LI	NBR	TB
00834BR	BR	50	72,1	10	LI	NBR	TB
00837B	B	40	70	12	LI	NBR	TB
00838B	B	53	75	12	LI	NBR	TB
00839BR	BR	32	50	8	LI	MVQ	TB
00847BAG	BAG	30	42	7	LI	NBR	TB
00849BA	BA	46,3	66,6	6,4	LI	NBR	TB
00853BR	BR	17	35	7	LI	NBR	TB
00866BR	BR	70	100	10	LI	NBR	TB
00867BR	BR	52	80,1	10	LI	NBR	TB
00879BR	BR	35	52,3	9,5	LI	NBR	TB
00880BR	BR	40	56	8	LI	NBR	TB
00891BRG	BRG	69,8	92	14,2	LI	NBR	TB
00893BA	BA	75	90	12	LI	NBR	TB
00897BR	BR	40	60	12	LI	NBR	TB
00900BR	BR	80	110	12	LI	NBR	TB
00903BA	BA	65	88,5	12,7	LI	NBR	TB
00904BRGE	BRGE	40,1	52	2,5/8,5	LI	NBR	K
00906BR	BR	70	85	8	LI	NBR	TB
00907BR	BR	63,5	76,1	9,5	LI	NBR	TB
00909BR	BR	20	47,1	10	LI	NBR	TB
00911BRG	BRG	30	50	11	LI	NBR	TB
00912BRG	BRG	35	52	12	LI	NBR	TB
00913BR	BR	40	80	10	LI	NBR	TB
00916BA	BA	15	28	7	LI	NBR	TB
00924BR	BR	40	57	12	LI	NBR	TB
00925BA	BA	25	42	8	LI	NBR	TB
00926BR	BR	65	85,1	10	LI	NBR	TB
00932BR	BR	28,6	39,8	7	LI	NBR	TB
00934B	B	25,4	41,3	9,5	LI	NBR	TB
00937B	B	22,2	35	8	LI	NBR	TB

Nº SABÓ	Tipo	Diâm. Eixo	Diâm. Alojamento	Altura Retentor	Orientação	Material Lábio	Grupo
00937BAG	BAG	22,2	34,9	8	LI	NBR	TB
00937BGO	BGO	22	34,8	8	LI	NBR	A
00946BR	BR	50	70	10	LI	NBR	TB
00947BR	BR	28	47,5	9,5	LI	NBR	TB
00949BR	BR	30	52	10	LI	NBR	TB
00950B	B	28,6	50,3	9,5	LI	NBR	TB
00952BR	BR	30	52	8	LI	NBR	TB
00953BR	BR	20	32,1	7	LI	NBR	TB
00955BAG	BAG	22	35	9	LI	NBR	TB
00961B	B	28,6	52,3	9,5	LI	NBR	TB
00962BR	BR	35	50	8	H	ACM	TB
00962BRGP	BRG	35	50	8	H	ACM	TB
00964B	B	55	90	12,5	LI	NBR	TB
00969BR	BR	35	47,1	9	LI	NBR	TB
00974BA	BA	52,4	76,2	7,9	LI	NBR	TB
00974GAO	GAO (216)	52,4	76,2	7,9	LI	NBR	A
00977BR	BR	60	82	12	LI	NBR	TB
00979BRGE	BRGE	40,1	52	3,5/9	LI	NBR	K
00980BA	BA	16	28	7	LI	NBR	TB
00981GA	GA	12,7	25,4	6,4	LI	NBR	TB
00989BAG	BAG	19	31,8	8	LI	NBR	TB
00992BRG	BRG	22	40	8	LI	NBR	TB
00994BA	BA	20	40	7	LI	NBR	TB
00994BRG	BRG	20	40	7	LI	NBR	TB
00995BA	BA	38,2	63,5	11,1	BI	NBR	TB
00998BR	BR	8,5	16	6,5	H	NBR	TB
01004BAG	BAG	35,5	58,2	13	BI	NBR	TB
01007BABEP	BABE	60,2	85,7	22,9	LI	ACM	A
01008BAGEP	BAGE (41)	54	81,1	22,9	LI	ACM	A
01009BR	BR	25,4	44,6	6,4	LI	NBR	TB
01017BR	BR	49	75	11	LI	NBR	TB
01019BR	BR	25	38	6,4	LI	NBR	TB
01022BR	BR	28,6	38	7	LI	NBR	TB
01028BE	BE	60,5	149,4	11,5	LI	NBR	O
01033BB	BB	38,1	63,5	19	LI	NBR	A
01035GR	GR	55	68	4	LI	NBR	TB
01038B	B	45	85	13	LI	NBR	TB
01040BA	BA	33,3	69,4	7,9	LI	NBR	TB
01041B	B	35	47,6	9,5	LI	NBR	TB
01043B	B	95	130	13	LI	NBR	TB
01044BAG	BAG	74	90	10	LI	NBR	TB
01045BRG	BRG	26	37	7	LI	NBR	TB
01046BAG	BAG	40	56	10	LI	NBR	TB
01049BRE	BRE	46	76,2	9,5/12,7	LI	NBR	B
01050BR	BR	60,4	79,4	9,3	LI	NBR	TB
01050BRGS	BRG	60,4	79,4	9,3	H	MVQ	TB
01058BR	BR	15	35	7	LI	NBR	TB
01064MV	MV	50,8	58	11,5	LI	PH	E
01072BR	BR	17	28	6	LI	NBR	TB

Nº SABÓ	Tipo	Diâm. Eixo	Diâm. Alojamento	Altura Retentor	Orientação	Material Lábio	Grupo
01074BRG	BRG	13	26	9	LI	NBR	TB
01081BR	BR	42	72	12	LI	NBR	TB
01089BRX	BRX	22	45	12	LI	NBR	G
01090BRXE	BRXE (251)	143	150	27	LI	NBR	G
01091GB	GB	73	101,7	17,4	LI	NBR	A
01093BR	BR	9,5	19,2	7	LI	NBR	TB
01095BRG	BRG	44,5	62	11	BI	NBR	TB
01095JOGO 2	KIT (s/ fig.)	44,5	62	12	BI	NBR	I
01097BR	BR	12,7	30	8	LI	NBR	TB
01100BAG	BAG	41	65,4	13	BI	NBR	TB
01102NXE	NXE	5	30	8,0 / 14,0	LI	NBR	G
01103B	B	108	133,3	9,5	LI	NBR	TB
01107BR	BR	18	40	9	LI	NBR	TB
01109BR	BR	40	62	11,5	LI	NBR	TB
01109BRG	BRG	40	62	11,5	LI	NBR	TB
01110BR	BR	19,3	29,1	6,4	LI	NBR	TB
01112BR	BR	22	38,1	8	LI	NBR	TB
01113BRG	BRG	17	35,1	7	LI	NBR	TB
01116BR	BR	40	60	10	LI	NBR	TB
01119BAG	BAG	44,2	71,5	14,8	H	NBR	TB
01125BBO	BBO	63,5	89,9	22,2	LI	NBR	A
01129GAE	GAE	20	47	10,0/12,7	LI	NBR	A
01129GRO	GRO	20	47	10,0/12,7	LI	NBR	A
01135BR	BR	70	90	10	AH	NBR	TB
01135BRGS	BRG	70	90	10	AH	MVQ	TB
01135BRP	BR	70	90	10	AH	ACM	TB
01140BR	BR	47	62,1	8	LI	NBR	TB
01141BR	BR	45	66,2	6	LI	NBR	TB
01147BRG	BRG	48	65,1	7	LI	NBR	TB
01148BR	BR	79,4	114,3	12,7	LI	NBR	TB
01149BA	BA	31,8	44,5	6,5	H	NBR	TB
01149BR	BR	31,7	44,5	6,5	LI	NBR	TB
01151BRG	BRG	26	42	10	LI	NBR	TB
01152GR	GR	35	46,5	4,8	LI	NBR	TB
01154B	B	31,7	44,5	9,5	LI	NBR	TB
01155B	B	40	55	9	LI	NBR	TB
01157BR	BR	34	62	10	LI	NBR	TB
01160BR	BR	65	80	8	LI	NBR	TB
01175BA	BA	15,9	25,4	6,4	LI	NBR	TB
01180BR	BR	55	85	13	LI	NBR	TB
01181BR	BR	55	70	8	LI	NBR	TB
01182BR	BR	30	72	9,5	LI	NBR	TB
01183BR	BR	75	105	13	LI	NBR	TB
01185BAX	BAX	82,5	114,3	14,3	LI	NBR	G
01188BR	BR	28,4	45	8,5	LI	NBR	TB
01193BR	BR	130	160	12	LI	NBR	TB
01194BR	BR	60	85	12,7	LI	NBR	TB
01195B	B	82,6	107,9	14,3	LI	NBR	TB
01199GB	GB	49	76	17,4	LI	NBR	A

Nº SABÓ	Tipo	Diâm. Eixo	Diâm. Alojamento	Altura Retentor	Orientação	Material Lábio	Grupo
01207BAG	BAG	45	67,9	12	LI	NBR	TB
01214BR	BR	24	37	7	LI	NBR	TB
01241BAG	BAG	49	65	10	LI	NBR	TB
01245BR	BR	20	40	6	LI	NBR	TB
01247BA	BA	55	76	12	LI	NBR	TB
01251BGO	BGO	92,1	123,9	21	LI	NBR	A
01252BGO	BGO	101,6	139,8	14,3	LI	NBR	A
01253B	B	89	114,3	12,7	LI	NBR	TB
01257B	B	95,3	120,6	12,7	LI	NBR	TB
01262BAG	BAG	49	68	12	LI	NBR	TB
01265BAG	BAG	40	56	9	LI	NBR	TB
01266BAG	BAG	40	65	12	LI	NBR	TB
01273BA	BA	30	62	10,1	LI	NBR	TB
01276GRE	GRE	39,5	54,5	0,2	LI	NBR	K
01278BA	BA	54	65	8	LI	NBR	TB
01289GRE	GRE	45	58,3	0,3	LI	NBR	K
01295GR	GR	25	40	5	LI	NBR	TB
01299BR	BR	28,6	38	7	LI	NBR	TB
01302B	B	25,4	47,6	11,1	LI	NBR	TB
01310BAG	BAG	32	42	7	LI	NBR	TB
01318B	B	38	70	12,7	LI	NBR	TB
01322BR	BR	40	62,1	10	LI	NBR	TB
01327BAG	BAG	25,4	38	9,5	LI	NBR	TB
01340BR	BR	50	68	10	LI	NBR	TB
01341BR	BR	24	40,1	10	LI	NBR	TB
01343BAG	BAG	34,9	63,0	13,0	H	NBR	TB
01344BR	BR	45	65	12	LI	NBR	TB
01345BA	BA	60,3	85,1	6,4	LI	NBR	TB
01348BR	BR	15	30	10	LI	NBR	TB
01353BRG	BRG	32	51,9	12	LI	NBR	TB
01355BR	BR	38,1	50,1	7	LI	NBR	TB
01356GAO	GAO(118)	25,4	38,1	6,8/13,5	LI	NBR	A
01362B	B	133,4	165,1	15,9	H	NBR	TB
01366B	B	35	72	10	LI	NBR	TB
01369BA	BA	47,6	70,5	13,5	LI	NBR	TB
01370BA	BA	31,9	44	9	LI	NBR	TB
01371BAG	BAG	35	54,9	11	LI	NBR	TB
01375BR	BR	100	120	11	LI	NBR	TB
01377B	B	31,7	52,3	9,5	LI	NBR	TB
01386BRG	BRG	20	35	8	LI	NBR	TB
01389BAG	BAG	14	24	7	LI	NBR	TB
01392BAG	BAG	60	80	12	LI	NBR	TB
01393BA	BA	25,4	50,7	10,2	LI	NBR	TB
01395B	B	34,9	52,3	9,5	LI	NBR	TB
01400BR	BR	18	47	8	LI	NBR	TB
01402F	F	NA	0	0	0	0	Q
01404BR	BR	20	35,1	4	LI	NBR	TB
01405GA	GA	25	35	5	LI	NBR	TB
01412B	B	114,3	152,4	12,7	LI	NBR	TB

Nº SABÓ	Tipo	Diâm. Eixo	Diâm. Alojamento	Altura Retentor	Orientação	Material Lábio	Grupo
01416BAG	BAG	90	110,1	13	LI	NBR	TB
01419GA	GA	40	50	4	LI	NBR	TB
01420BR	BR	12	28,1	7	LI	NBR	TB
01421BR	BR	36	54	7,5	LI	NBR	TB
01422BR	BR	50	65	8	LI	NBR	TB
01423BR	BR	8	18	5	LI	NBR	TB
01424BR	BR	150	180	15	LI	NBR	TB
01425BA	BA	62	100,1	17	LI	NBR	TB
01460B	B	47,6	82,8	11	LI	NBR	TB
01466MFBE	MFBE (sem figura)	114	174,4	16		ES-TAMPADO	I
01466MFBE*	MFBE	114	174,4	16	0	ES-TAMPADO	R
01468B	B	108	136,5	12,7	LI	NBR	TB
01479BR	BR	11,1	25,4	6	LI	NBR	TB
01481BA	BA	22	41,3	8	AH	NBR	TB
01492BR	B	17	40	8,5	LI	NBR	TB
01493BR	BR	15,9	28,5	7	LI	NBR	TB
01495BR	BR	28	40	7	LI	NBR	TB
01495BRF	BR	28	40	7	LI	FPM	TB
01495BRS	BR	28	40	7	LI	MVQ	TB
01502BA	BA	35,0	44,5	7,0	LI	NBR	TB
01505BR	BR	42	65,1	10	LI	NBR	TB
01506BF	B	42	65	12	LI	FPM	TB
01507BR	BR	24	42	10	LI	NBR	TB
01509BR	BR	34	52	7,5	LI	NBR	TB
01511BR	BR	17	35	8	LI	NBR	TB
01515BR	BR	25	36	7	LI	NBR	TB
01526BRG	BRG	35	46,5	6,4	LI	NBR	TB
01532BR	BR	44,5	65,1	8	LI	NBR	TB
01535BR	BR	30	40	7	LI	NBR	TB
01536BA	BA	38,1	47,6	6,4	LI	NBR	TB
01543BA	BA	25	35	7	LI	NBR	TB
01543BR	BR	25	35	7	LI	NBR	TB
01546GRX	GRX	46	65,6	11,1	LI	NBR	G
01549BR	BR	100	125	12	LI	NBR	TB
01549BRA	BRA	100	125	12	LI	NBR	TB
01550BR	BR	55	72	10	LI	NBR	TB
01550BRP	BR	55	72	10	LI	ACM	TB
01551BR	BR	35	58	10	LI	NBR	TB
01552BR	BR	44	60	10	LI	NBR	TB
01553BR	BR	45	72	9,5	LI	NBR	TB
01554BRG	BRG	22	32	7	LI	NBR	TB
01556BR	BR	25	40	8	LI	NBR	TB
01557BR	BR	55	70,1	11,5	LI	NBR	TB
01559BR	BR	12,7	22,2	8	LI	NBR	TB
01563BA	BA	32	47,5	6,4	LI	NBR	TB
01566BAO	BAO	20	30	4,0/7,0	LI	NBR	A
01571BBR	BBR (183)	82,6	107,9	16	LI	NBR	A

Nº SABÓ	Tipo	Diâm. Eixo	Diâm. Alojamento	Altura Retentor	Orientação	Material Lábio	Grupo	Nº SABÓ	Tipo	Diâm. Eixo	Diâm. Alojamento	Altura Retentor	Orientação	Material Lábio	Grupo
01576BAG	BAG	16	22,1	6,4	LI	NBR	TB	01742BR	BR	35	52,1	10	LI	NBR	TB
01577BR	BR	25	37,1	7,3	LI	NBR	TB	01743BS	B	30	52	9	LI	MVQ	TB
01580B	B	28	42	7	LI	NBR	TB	01744B	B	32	52	9	LI	NBR	TB
01581BGO	BGO	30	72	10	LI	NBR	A	01745BR	BR	40	55,1	10	LI	NBR	TB
01587BR	BR	8	22	8	LI	NBR	TB	01746B	B	20	42	10	LI	NBR	TB
01589BR	BR	33	52	6	LI	NBR	TB	01751BRG	BRG	27	40	7	LI	NBR	TB
01595BAGE	BAGE	50,8	116	16,2	LI	NBR	O	01755BA	BA	60,2	85,8	9,5	BI	NBR	TB
01602BAG	BAG	40	72	12	LI	NBR	TB	01760GR	GR	45	62	8	LI	NBR	TB
01604BR	BR	25	42	6	LI	NBR	TB	01764BAGG	BAGG	46	65,5	7/8,5	LI	NBR	A
01625BR	BR	27	42	10	LI	NBR	TB	01765BRGE	BRE (190)	25,6	42	7,0/10,3	BI	NBR	A
01630BAG	BAG	31,7	42,8	7,9	LI	NBR	TB	01767BR	BR	85	110	12	LI	NBR	TB
01635BR	BR	28,6	57,2	9,5	LI	NBR	TB	01769BR	BR	18	35	10	LI	NBR	TB
01637GA	GA	55,1	82	10	LI	NBR	TB	01770B	B	118	140	13	LI	NBR	TB
01656BR	BR	44,5	70	10	LI	NBR	TB	01774BRG	BRG	105	135	15	LI	NBR	TB
01657BA	BA	38	57	7	LI	NBR	TB	01779B	B	22	47	9	LI	NBR	TB
01660BAGE	BAGE (239)	39,4	80,3	6,40/11,80	H	NBR	A	01783BRG	BRG	50	65	8,5	LI	NBR	TB
01661BAG	BAG	28,6	43	9,5	LI	NBR	TB	01790B	B	63,5	82,5	12,7	LI	NBR	TB
01662GAE	GAE	9	16	9/15,0	LI	NBR	A	01791BF	BF	87,3	114,3	22,2	LI	NBR/FE	A
01666BR	BR	24	36	6	LI	NBR	TB	01795BAGE	BAGE (80)	58	98	12,8	LI	NBR	O
01667BR	BR	30	42,1	8	LI	NBR	TB	01796MA	MA	52,4	61,2	11,5	LI	MA	E
01669BR	BR	55	100	12,7	LI	NBR	TB	01798BAG	BAG	58	85	13	LI	NBR	TB
01671GA	GA	50,8	65,1	12,7	LI	NBR	TB	01801B	B	100	123,8	13	LI	NBR	TB
01672BR	BR	10	22	7	LI	NBR	TB	01802BR	BR	42	62	6	LI	NBR	TB
01673BA	BA	75	95	5	LI	NBR	TB	01803BAG	BAG	38,1	50,4	11	LI	NBR	TB
01676BR	BR	185	210	13	LI	NBR	TB	01805BE	BE	100	128	15/25	LI	NBR	B
01677BR	BR	15	30	7	LI	NBR	TB	01807BAG	BAG	50	70	12	LI	NBR	TB
01679BRG	BRG	44,5	68,2	15,9	LI	NBR	TB	01810BAGS	BAG	65	90	15	H	MVQ	TB
01684BRGGG	BRGGG	40	62	12	LI	NBR	A	01810BRAGF	BRAG	65	90	15	H	FPM	TB
01685BR	BR	6,4	19,1	6,4	LI	NBR	TB	01811B	B	39,7	63,5	12,7	LI	NBR	TB
01695BR	BR	30	47	6	LI	NBR	TB	01814BRG	BRG	36	60	9,5	BI	NBR	TB
01699BR	BR	47,6	69,9	9,5	LI	NBR	TB	01815BAEP	BAE	9	15	14	LI	ACM	F
01707BRG	BRG	40	55	8	LI	NBR	TB	01816BA	BA	15	24	7,4	AH	NBR	TB
01710BAG	BAG	38	74	11	LI	NBR	TB	01817BA	BA	16	30	6,4	AH	NBR	TB
01711BRG	BRG	45	64	9	LI	NBR	TB	01821MFE	MFE (A)	60	75	5	0	Metal/Feltro	P
01712BAG	BAG	24,6	39,9	8	LI	NBR	TB	01825BRG	BRG	54	76	8	AH	NBR	TB
01715BR	BR	32	43	7	LI	NBR	TB	01828B	B	61,9	80	10	LI	NBR	TB
01716BR	BR	22	35	7	LI	NBR	TB	01829B	B	90	112,7	13	LI	NBR	TB
01721BR	BR	99,9	130	12	LI	NBR	TB	01831BA	BA	30	46,4	10	LI	NBR	TB
01721BRGP	BRG	100	130	12	LI	ACM	TB	01832BR	BR	38	58,5	7	BI	NBR	TB
01722BAE	BAE	24,6	44,5	1,5/7,9	LI	NBR	B	01833BA	BA	29,9	45	7	H	NBR	TB
01724BAE	BAE	27	42,7	1,2/7,9	LI	NBR	B	01834BAGE	BAGE	33	50	10,0/15,0	AH	NBR	B
01725BR	BR	17	32	7	LI	NBR	TB	01835BR	BR	14,3	24	7	LI	NBR	TB
01727BR	BR	22	32	5,5	LI	NBR	TB	01837BRGE	BRGE (194)	17	28	0,7	H	NBR	A
01735BG	BG	125	150	15	LI	NBR	TB	01838BAG	BAG	54	79,4	12,7	AH	NBR	TB
01737BR	BR	11	17	4	LI	NBR	TB	01839BA	BA	33	50	8	H	NBR	TB
01737BRF	BR	11	17	4	LI	FPM	TB	01840BGO	BGO	48	65	12	AH	NBR	A
01738B	B	45	60	10	LI	NBR	TB	01841BRG	BRG	60	82	12	AH	NBR	TB
01739B	B	110,3	133,3	12	LI	NBR	TB	01842BRG	BRG	60	82	12	H	NBR	TB
01740B	B	50	65	10	LI	NBR	TB	01844BAG	BAG	34,9	55,9	12,5	AH	NBR	TB



Nº SABÓ	Tipo	Diám. Eixo	Diám. Alojamento	Altura Retentor	Orientação	Material Lábio	Grupo
01846BAG	BAG	15	30	7	LI	NBR	TB
01849BAG	BAG	33	51,9	12	BI	NBR	TB
01849BAGE	BAGE	33	51,9	0,3	BI	NBR	K
01850BRGE	BRGE	38	52	2,5/8,5	LI	NBR	K
01851BRG	BRG	45	60	10	H	NBR	TB
01854BRG	BRG	38,1	60,4	12,7	H	NBR	TB
01855BAG	BAG	50	87	12,7	LI	NBR	TB
01856BRGP	BRG	75,9	95	11,3	AH	ACM	TB
01857B	B	76,2	98,5	11,9	LI	NBR	TB
01858BAGE	BAGE (173)	44,4	54	8,6	LI	NBR	A
01859BAG	BAG	44,5	61,9	9,5	H	NBR	TB
01860BA	BA	26	45	10	LI	NBR	TB
01861BRG	BRG	50	72	12	LI	NBR	TB
01862BAG	BAG	57,3	76,2	9,5	LI	NBR	TB
01863BA	BA	63,5	88,9	12,7	LI	NBR	TB
01864BAG	BAG	54	76,2	12,7	LI	NBR	TB
01865BGO	BGO	69,8	95,3	16	LI	NBR	A
01873GRE	GRE (219)	30,5	38	7,9	LI	NBR	A
01875BR	BR	14	32	10	LI	NBR	TB
01876GRXE	GRXE	20,9	30,1	12	LI	NBR	G
01877BAG	BAG	38,2	60,4	12,7	AH	NBR	TB
01878B	B	50,8	71,9	11,9	LI	NBR	TB
01879BRG	BRG	70	95	13	AH	NBR	TB
01880BAG	BAG	69,8	98,5	11,8	H	NBR	TB
01880BAGE	BAGE	69,8	98,5	11,8/17,7	H	NBR	B
01883BAG	BAG	21	32	7	LI	NBR	TB
01884BRAG	BRAG	120	145	15	BI	NBR	TB
01885BAGP	BAG	120	140,2	13	H	ACM	TB
01886GR	GR	28	38	6,5	LI	NBR	TB
01889GAO	GAO (244)	15	35	10,0/12,7	LI	NBR	A
01892BRG	BRG	25	37,9	7	LI	NBR	TB
01894BRG	BRG	19,9	35	7	LI	NBR	TB
01895BRG	BRG	29,9	52	8	LI	NBR	TB
01898BRGEP	BRGE	39,4	80,3	6,4/16,2	H	ACM	B
01899BRGE	BRGE	42,9	65	9,5/15,0	BI	NBR	B
01900GAE	GAE	85,7	108	7,9/14,6	LI	NBR	B
01901BGO	BGO	101,8	127,1	11,9	LI	NBR	A
01902BR	BR	48	72	10	H	NBR	TB
01903BRP	BR	30	40	7	H	ACM	TB
01905BR	BR	35	58	10	BI	NBR	TB
01906BA	BA	45	72	10	LI	NBR	TB
01907BR	BR	15	32	7	LI	NBR	TB
01909BR	BR	19	29,1	6,4	LI	NBR	TB
01910BRP	BR	150	180	13	H	ACM	TB
01910BRS	BR	150	180	13	H	MVQ	TB
01911BRG	BRG	45	60	9	H	NBR	TB
01911BRGF	BRG	45	60	9	H	FPM	TB
01912BRG	BRG	85,7	114,2	11,2	LI	NBR	TB
01917BRGS	BRG	78	100	13	H	MVQ	TB

Nº SABÓ	Tipo	Diám. Eixo	Diám. Alojamento	Altura Retentor	Orientação	Material Lábio	Grupo
01918BRGE	BRGE	44	65	2,5/12,2	LI	NBR	K
01923BG	BG	82,5	114,3	12,7	BI	NBR	TB
01924BAE	BAE	10	15	0,7	LI	ACM	F
01927BRP	BR	70	90,5	10	AH	ACM	TB
01928B	B	146	168,3	16	H	NBR	TB
01929BAG	BAG	15	24	7	LI	NBR	TB
01929BRG	BRG	15	24	7	LI	HNBR	TB
01930BAG	BAG	54,1	73	8,5	LI	NBR	TB
01931BAG	BAG	41,4	70,6	7,9	LI	NBR	TB
01932GRE	GRE	59	79,7	9,7/11,8	LI	NBR	B
01933BABEP	BABE(54)	54	81,1	20,7	BI	ACM	A
01934BAG	BAG	15,9	30	6	H	NBR	TB
01935BAG	BAG	20	30	7	LI	NBR	TB
01942BRGP	BRG	32	47	10	H	ACM	TB
01943BAGEP	BAGE(115)	43,3	56,2	1,7	H	ACM	B
01945BRGS	BRG	82	105	12	AH	MVQ	TB
01949BR	BR	35	62	10	AH	NBR	TB
01950BAG	BAG	52	72	10	H	NBR	TB
01951BR	BR	160	200	12	LI	NBR	TB
01952BA	BA	30	52	12	AH	NBR	TB
01954BR	BR	35	80	12	H	NBR	TB
01958BAGS	BAG	40,5	54	7,2	BI	MVQ	TB
01959BAG	BAG	15	35	7	LI	NBR	TB
01962BA	BA	28,6	41,3	9,4	AH	NBR	TB
01963BAG	BAG	41	49,3	6,5	H	NBR	TB
01964BA	BA	28,6	38,1	6,5	H	NBR	TB
01965BAP	BA	19	35	10,3	BI	ACM	TB
01966BA	BA	12,7	25,4	6,4	BI	NBR	TB
01969BRGS	BRG	55	72	10	H	MVQ	TB
01974BRG	BRG	100	130	13	LI	NBR	TB
01976B	B	165,1	193,7	15,7	LI	NBR	TB
01980BR	BR	35	55	8	LI	NBR	TB
01981BRGS	BRG	85	105	12	AH	MVQ	TB
01985BR	BR	21	32	7	LI	NBR	TB
01988BRG	BRG	40	52	7,4	LI	NBR	TB
01992BR	BR	30,3	39,7	6,4	H	NBR	TB
01993BR	BR	27	38,1	6,4	AH	NBR	TB
01994BR	BR	49,2	79,4	12,5	H	NBR	TB
01995BR	BR	58,7	79,4	9,6	H	NBR	TB
01997BRO	BRO	39,4	60,3	12,7	LI	NBR	A
01998BR	BR	28,6	39,8	6,4	LI	NBR	TB
02002U	U (B)	22	32	8	LI	NBR	C
02004BAGP	BAG	64	80	8	AH	ACM	TB
02005BAGP	BAG	40	56	7	H	ACM	TB
02006BAG	BAG	30	52	7	H	NBR	TB
02007BAGP	BAG	25	35	7,5	BI	ACM	TB
02008BAGE	BAGE	16	26	20	LI	NBR	D
02009BP	B	22	40	8	H	ACM	TB
02010BAG	BAG	25	47	7	LI	NBR	TB

Nº SABÓ	Tipo	Diâm. Eixo	Diâm. Alojamento	Altura Retentor	Orientação	Material Lábio	Grupo	Nº SABÓ	Tipo	Diâm. Eixo	Diâm. Alojamento	Altura Retentor	Orientação	Material Lábio	Grupo
02010BRO	BRO	25	47	7	LI	NBR	A	02107GA	GA	25	35	5	LI	NBR	TB
02012BRF	BR	33	45	7	LI	FPM	TB	02108BRG	BRG	50	68	9	LI	NBR	TB
02013BAP	BA	8	16	7	H	ACM	TB	02110BRG	BRG	45	62	9	LI	NBR	TB
02018BAGE	BAGE(42)	88,9	152,4	39,1	LI	NBR	A	02111BRG	BRG	55	72	9	LI	NBR	TB
02019BAGE	BAGE(42)	82,6	134,6	41,2	LI	NBR	A	02112BRG	BRG	58	75	9	LI	NBR	TB
02020S	S (150)	14,2	50,7	46,1	LI	NBR	U	02113BR	BR	65	100	13	AH	NBR	TB
02023GRGGO	GRGGO	30	42	8	LI	NBR	D	02115BRGS	BRG	122,2	140,8	11,8	AH	MVQ	TB
02024BRGG	BRGG	47	58	7	LI	NBR	A	02116BAP	BA	60,3	82,5	11	H	ACM	TB
02025BA	BA	14	20	3,5	LI	NBR	TB	02118BREP	BRE (113)	8	14,1	7,1/10,4	LI	ACM	F
02026GGGX	GGGX	52,4	74,7	8,4	LI	NBR	G	02125BGP	BG	95,3	114,3	12	AH	ACM	TB
02027BGO	BGO	41,1	62,1	16	H	NBR	A	02128BA	BA	38	62	7	LI	NBR	TB
02031BR	BR	40	56	7	LI	NBR	TB	02130BAG	BAG	15	21	4	LI	NBR	TB
02032BA	BA	25,4	35	6,4	H	NBR	TB	02131BAG	BAG	19	28,6	6,5	LI	NBR	TB
02033BAE	BAE	63,6	155,6	12	BI	NBR	O	02132BRES	BRE	22,3	35,7	3,7/10	H	MVQ	K
02034BRG	BRG	38,1	63,6	12,7	H	NBR	TB	02134BGE	BGE	117,4	157,1	13,5/26,5	BI	NBR	B
02038BRG	BRG	39,4	63,6	12,7	BI	NBR	TB	02138B	B	174,6	200	16	LI	NBR	TB
02039BR	BR	42	72	10	AH	NBR	TB	02139BRG	BRG	48	72	7	LI	NBR	TB
02044BAGE	BAGE	150,8	229,4	28,6	BI	NBR	O	02142BRGF	BRG	32	47	10	BI	FPM	TB
02046BRG	BRG	25	47	10	LI	NBR	TB	02143BRGGG	BRGGG	21	37	7,0/10,0	LI	NBR	A
02049BG	BG	100	120	13	BI	NBR	TB	02145BRG	BRG	28	42	7	LI	NBR	TB
02051BR	BR	38	54	10	LI	NBR	TB	02148BRG	BRG	25	40	9	LI	NBR	TB
02053BAGP	BAG	41,3	63,6	6,5	BI	ACM	TB	02151BA	BA	35	80	6	LI	NBR	TB
02055BR	BR	47,7	65	8	H	NBR	TB	02152BAGGG	BAGGG	34	55	11,0/15,0	LI	NBR	A
02058BAGF	BAG	42	55	9	LI	FPM	TB	02153BRG	BRG	29,4	42,8	8	LI	NBR	TB
02059BA	BA	42	58	7	LI	NBR	TB	02157BRO	BRO	28	40	8	LI	NBR	A
02062BA	BA	25	40	7	LI	NBR	TB	02161BR	BR	17	25	4	LI	NBR	TB
02063BAG	BAG	31,7	50,8	11,1	LI	NBR	TB	02162BRG	BRG	14	24	6	LI	NBR	TB
02064BAG	BAG	22,2	50,8	11,1	LI	NBR	TB	02163BRG	BRG	8	18	5	LI	NBR	TB
02066BAG	BAG	57,2	73	8	BI	NBR	TB	02164BRG	BRG	18	37	8	LI	NBR	TB
02068BRGP	BRG	40	52	9	BI	ACM	TB	02165GRGG	GRGG	26	42	8	LI	NBR	D
02069BRGS	BRG	130	160	15	AH	MVQ	TB	02169BA	BA	45	62	7	LI	NBR	TB
02072BAP	BA	20	38,1	6,4	LI	ACM	TB	02171BR	BR	10	19	6,5	LI	NBR	TB
02073GA	GA	21,8	25	1,9	LI	NBR	TB	02178BRAGS	BRAG	35	48	7	H	MVQ	TB
02075BREP	BRE (192)	20	35	7,0/10,6	H	ACM	A	02180BG	BG	114,3	155,6	14	BI	NBR	TB
02077BAG	BAG	60,3	79,4	9,5	H	NBR	TB	02185BAGF	BAG	140	165	15	AH	FPM	TB
02084BAGP	BAG	41,2	63,5	8	H	ACM	TB	02192BRGP	BRG	70	90	10	BI	ACM	TB
02085BA	BA	69,9	89	12,7	AH	NBR	TB	02194GB	GB	101,6	127	16	LI	NBR	A
02087BAG	BAG	35	56	10	BI	NBR	TB	02195BR	BR	105	140	12	BI	NBR	TB
02090BABE	BABE (54)	60,3	85,8	22,8	BI	NBR	A	02196BR	BR	44,3	81	12,5	LI	NBR	TB
02093BRG	BRG	150,8	177,8	12,5	LI	NBR	TB	02197BRG	BRG	54	73	9,5	AH	NBR	TB
02095GA	GA	35,0	42,0	4,0	LI	NBR	TB	02201BRGEP	BRGE	47,6	80,3	6,5/16,5	H	ACM	B
02096BA	BA	30	37,1	4	LI	NBR	TB	02203BAG	BAG	18,8	31,7	11	LI	NBR	TB
02097BREP	BRE (109)	8	14,1	10,4	LI	ACM	F	02204BAGP	BAG	60,3	90	12,5	LI	ACM	TB
02098BAE	BAE	60,3	149,4	8,3	BI	NBR	O	02205BAGP	BAG	54	90	12,5	BI	ACM	TB
02099BA	BA	36	54	7	H	NBR	TB	02206BAGP	BAG	60,3	79,4	12	BI	ACM	TB
02100BAG	BAG	58	75	12	AH	NBR	TB	02207BAGP	BAG	54	73	11	BI	ACM	TB
02102BA	BA	34,9	50,9	8,3	H	NBR	TB	02208BAGP	BAG	90	120	12	BI	ACM	TB
02103BAG	BAGE(16)	57,2	82,5	9,5/11,5	AH	NBR	B	02209BAGE	BAGE	47,6	80	13,0/26,0	BI	NBR	B
02104BA	BA	44,5	63,6	8	H	NBR	TB	02210BRG	BRG	24	37	7	LI	NBR	TB

Nº SABÓ	Tipo	Diám. Eixo	Diám. Alojamento	Altura Retentor	Orientação	Material Lábio	Grupo
02211BAG	BAG	63,5	83,8	9,0/11,5	BI	NBR	B
02212BRGE	BRGE	40	52	2,8/8,5	LI	NBR	K
02213B	B	98,4	126,9	12	LI	NBR	TB
02214B	B	114,3	139,7	12,7	LI	NBR	TB
02219BAGF	BAG(17)	155	180	16/29	BI	FPM	A
02221BA	BA	34,9	50,8	8,3	LI	NBR	TB
02223B	B	140	180	15	LI	NBR	TB
02224BR	BR	35	56	10	AH	NBR	TB
02225BR	BR	40	68	12	AH	NBR	TB
02226BG	BG	75	100	13	BI	NBR	TB
02233BRG	BRG	25	40	8	BI	NBR	TB
02234BRG	BRG	30	42	10	LI	NBR	TB
02235BAGS	BAG	80	100	12	H	MVQ	TB
02236BAP	BA	57	85	12	BI	ACM	TB
02241GRG	GRG	25	47	8	LI	NBR	A
02244B	B	29	50	10	AH	NBR	TB
02245BAG	BAG	133,4	155,6	14	BI	NBR	TB
02246BAG	BAG	168	188	31,5	BI	NBR	TB
02246BAGF	BAG	168	188	31,5	BI	FPM	TB
02259GAG	GAG(103)	26	34	5	LI	NBR	A
02261GAE	GAE	25	35	5,0/7,0	LI	NBR	A
02262BAG	BAG	50,8	65,1	12,7	LI	NBR	TB
02264BRGF	BRG	85,9	104	11	AH	FPM	TB
02265GA	GA	25	32	4	LI	NBR	TB
02267BBO	BBO(180)	60,3	85,8	23,8	LI	NBR	A
02269BAGP	BAG	70	85	8	AH	ACM	TB
02271BGP	BG	66,7	92	11	BI	ACM	TB
02272BGP	BG	66,7	85,6	12	BI	ACM	TB
02279BAG	BAG	15	26	6	LI	NBR	TB
02283BRGF	BRG	85	105	12	AH	FPM	TB
02287BGP	BG	54	79,4	9,5	BI	ACM	TB
02289BAG	BAG	38	74	11	H	NBR	TB
02291BAF	BA	80	100	12	H	FPM	TB
02292BAF	BA	68	90	10	AH	FPM	TB
02293BF	B	145	175	13	BI	FPM	TB
02295BA	BA	44	58	7	LI	NBR	TB
02296BRG	BRG	42	60	9	AH	NBR	TB
02297BAGF	BAG	70	85	8	AH	FPM	TB
02298BRG	BRG	45	62	9	AH	NBR	TB
02302BAGF	BAG	40	56	7	H	FPM	TB
02303BRG	BRG	35	63,1	14	LI	NBR	TB
02304BRG	BRG	35	60,3	9,5	LI	NBR	TB
02305BAG	BAG(130)	46,3	66,6	0,8/6,7	BI	NBR	A
02306BRG	BRG	6,5	14,5	7	LI	NBR	TB
02307NEP	NE(34)	5,5	9,2	0,9	LI	ACM	F
02308BRG	BRG	14	28	7	LI	NBR	TB
02309BRP	BR	15	25	7	AH	ACM	TB
02310BRG	BRG	16	28	7	LI	NBR	TB
02311BR	BR	20	34	7	AH	NBR	TB

Nº SABÓ	Tipo	Diám. Eixo	Diám. Alojamento	Altura Retentor	Orientação	Material Lábio	Grupo
02312BRGE	BRGE(21)	27	39	10,5	LI	NBR	D
02315GA	GA	34,9	53,5	6,5	LI	NBR	TB
02317BRAGF	BRAG	31	50	8	H	FPM	TB
02318BRGE	BRGE(21)	30	40,5	10,5	LI	NBR	D
02319BRGE	BRGE(58)	15	21	0,1	LI	NBR	K
02321BAG	BAG	42	56	7	LI	NBR	TB
02324BRG	BRG	45	65	8	LI	NBR	TB
02325BRGP	BRG	90	115	13	AH	ACM	TB
02326BRGP	BRG	58	80	12	H	ACM	TB
02333BAE	BAE	60,3	155,5	8	BI	NBR	O
02335BAG	BAG	15,9	22,2	4,3	LI	NBR	TB
02336BROE	BROE	35	45,2	15/24	LI	NBR	A
02351BAGE	BAGE	80	112	12,0/18,0	H	NBR	B
02353BRGE	BRGE(21)	35	48	10,5	LI	NBR	D
02360BRF	BR	12,5	20	5	BI	FPM	TB
02370BRAGE	BRAGE	35	54	10,0/15,0	BI	NBR	B
02371BAG	BAG	21	32	7,5	H	NBR	TB
02372BAG	BAG	23	35	8	H	NBR	TB
02373BRG	BRG	13	26	7	LI	NBR	TB
02374BAGE	BAGE(61)	35	54,9	0,7/14,7	BI	NBR	K
02375BR	BR	17	28,1	5	LI	NBR	TB
02376BRG	BRG	30	47	7	AH	NBR	TB
02377BG	BG	40	62	12	LI	NBR	TB
02378BR	BR	44,3	60	7	LI	NBR	TB
02380BRXE	BRXE(35)	8	35	13	LI	NBR	G
02382BREP	BRE(32)	7	10,9	6,4/11	LI	ACM	F
02385BA	BA	38,1	47,6	7	H	NBR	TB
02386BG	BG	108	133,4	12	BI	NBR	TB
02391BRG	BRG	40	55	8	BI	NBR	TB
02392BRGE	BRGE(13)	55	70	6,0/10,3	BI	NBR	B
02393BAGE	BAGE	54	79,4	12,7/19,0	AH	NBR	B
02395BAGG	BAGG	45	73,1	13	BI	NBR	A
02396BREF	BRE(108)	8	12	11	LI	FPM	F
02397BRG	BRG	32	45	7	AH	NBR	TB
02400BREF	BRE(111)	8	14,1	13,8/13	LI	FPM	F
02401B	B	30	52	9	LI	NBR	TB
02408BRGO	BRGO	20	32,3	10	LI	NBR	A
02412BRG	BRG	26	40	8	H	NBR	TB
02413BRG	BRG	28	40	8	H	NBR	TB
02414BRG	BRG	25	35	8	H	NBR	TB
02415BAG	BAG	55,4	76,2	12,7	LI	NBR	TB
02416BAG	BAG	82,5	120	15	BI	NBR	TB
02417BAGE	BAGE	60,3	92	12,0/18,5	AH	NBR	B
02418BRP	BR	21,5	40	7	H	ACM	TB
02419BAG	BAG	40	55	9,5	BI	NBR	TB
02420BAGE	BAGE(26)	15,5	28	0,4	LI	NBR	D
02423BAG	BAG	69,8	90	10	LI	NBR	TB
02424BG	BG	89	114,3	12,7	LI	NBR	TB
02425BR	BR	17	32	7	LI	NBR	TB

Nº SABÓ	Tipo	Diâm. Eixo	Diâm. Alojamento	Altura Retentor	Orientação	Material Lábio	Grupo
02426BRG	BRG	58	75	9	AH	NBR	TB
02433BRG	BRG	20	39,7	6,5	LI	NBR	TB
02438BRG	BRG	39,4	63,6	12,5	AH	NBR	TB
02442BAGE	BAGE	50	65	9,7/14,0	BI	NBR	B
02445BR	BR	68	90	10	LI	NBR	TB
02448BRAGF	BRAG	60,3	82,5	11	H	FPM	TB
02449BRGF	BRG	122,2	140,8	12	AH	FPM	TB
02451BRG	BRG	75	90	10	LI	NBR	TB
02454BRG	BRG	15	25	7	LI	NBR	TB
02456BRGS	BRG	35	50	8	H	MVQ	TB
02461BRGE	BRGE (21)	28,5	39,8	8	LI	NBR	D
02464BRO	BRO	94,7	120	12	LI	NBR	A
02468BRG	BRG	20	40	7	LI	NBR	TB
02469GRG	GRG	40	50	5	LI	NBR	A
02478BAGF	BAG	63,5	82,6	12,7	AH	FPM	TB
02480BAGP	BAG	20,6	38,1	7	LI	ACM	TB
02481BRAGF	BRAG	35	65	8	BI	FPM	TB
02483BGE	BGE	88,9	115,4	16,2/19,2	BI	NBR	B
02484BGE	BGE	88,9	123	18,7/21,7	BI	NBR	B
02485BY	BY	98,4	144,5	16	BI	NBR	M
02486BR	BR	20	35	7	LI	NBR	TB
02490BY	BY (69)	142,8	182,5	24	BI	NBR	M
02491GR	GR	8	15	3	LI	NBR	TB
02492GR	GR	16	22	3	LI	NBR	TB
02494BRAGF	BRAG	42	72	10	H	FPM	TB
02495BRF	BR	8	14	3	LI	FPM	TB
02496BY	BY	127	158,8	16	BI	NBR	M
02498BRGF	BRG	63,5	88,9	11	H	FPM	TB
02505BA	BA	38	47,6	6,5	LI	NBR	TB
02506BR	BR	38	52,3	7	LI	NBR	TB
02509BREF	BRE (108)	7	11	7	LI	FPM	F
02511BRAGF	BRAG	66,7	88,8	11,0/12,5	H	FPM	TB
02512BRGEP	BRGE (67)	57,2	82,6	0,9/14	AH	NBR/ACM	L
02513BREF	BRE (107)	9,4	15,9	12,6	LI	FPM	F
02515GR	GR	6	10	2,5	LI	NBR	TB
02519BRG	BRG	28	40	8	LI	NBR	TB
02523BRF	BR	11	17	4	LI	FPM	TB
02525BRAGF	BRAG	26	42	8	H	FPM	TB
02528GRL	GRL	35,6	50,8	7,8/9,6	LI	NBR	A
02529BRG	BRG	55	80	8	H	NBR	TB
02530BRG	BRG	65	85	10	LI	NBR	TB
02531BR	BR	75	95	10	BI	NBR	TB
02533BRGP	BRG	22	35	7	AH	ACM	TB
02534GAG	GAG	14	20	2,5	LI	NBR	A
02535BRG	BRG	12	22	5	LI	NBR	TB
02536BR	BR	8	14	3	LI	NBR	TB
02539BRGP	BRG	30	42	7	H	ACM	TB
02544BREF	BRE (108)	8	10,8	10,3	LI	FPM	F
02556BAF	BA	68	85	10	H	FPM	TB
02557BRG	BRG	68	85	10	LI	NBR	TB
02558BAF	BA	47,6	57,2	5	H	FPM	TB
02562BRGEP	BRGE (67)	69,8	98,4	2,5/11,5	H	ACM	L
02566BRGF	BRG	20	40	7	LI	FPM	TB
02568BRG	BRG	26	35	7	LI	NBR	TB
02569BRGP	BRG	14	22	4	LI	ACM	TB
02570BRGF	BRG	25	40	7	LI	FPM	TB
02571BRG	BRG	17	25	4	LI	NBR	TB
02572BRG	BRG	22	35	7	LI	NBR	TB
02573GR	GR	20	26	4	LI	NBR	TB
02574BR	BR	90	110	12	BI	NBR	TB
02576GAG	GAG	14,2	28,6	13,5	LI	NBR	A
02578BRGF	BRG	60,4	79,4	9,3	H	FPM	TB
02579BRG	BRG	22	35	7	LI	NBR	TB
02580BAG	BAG	44,4	63,5	12,7	BI	NBR	TB
02583BRGF	BRG	133,3	158,8	13	AH	FPM	TB
02588GR	GR	25	32	4	LI	NBR	TB
02589GR	GR	15	21	3	LI	NBR	TB
02590NF	N (114)	9,5	14,3	14,3	LI	FPM	F
02593BR	BR	30	47	6	AH	NBR	TB
02594BRF	BR	24	35	6	H	FPM	TB
02604BRGF	BRG	92,1	107,7	10	AH	FPM	TB
02606BAF	BA	85	105	10	H	FPM	TB
02607BRG	BRG	85	105	11	LI	NBR	TB
02619BRAGF	BRAG	112,5	130	11	AH	FPM	TB
02629BRAGF	BRAG	91	111	10	AH	FPM	TB
02632GR	GR	35,0	42,0	4,0	LI	NBR	TB
02633GR	GR	40	50	4	LI	NBR	TB
02634GR	GR	45	55	4	LI	NBR	TB
02635GR	GR	55	65	5	LI	NBR	TB
02636GR	GR	60	72	6	LI	NBR	TB
02637GR	GR	70	85	7	LI	NBR	TB
02638GR	GR	12	18	3	LI	NBR	TB
02639GR	GR	15	23	3	LI	NBR	TB
02640GR	GR	17	25	3	LI	NBR	TB
02641GR	GR	20	28	4	LI	NBR	TB
02642GR	GR	25	32	4	LI	NBR	TB
02643GR	GR	30	37	4	LI	NBR	TB
02656BRAAF	BRA	55	70,1	8	AH	FPM	TB
02662BRG	BRG	80	100	12	AH	NBR	TB
02664BAGP	BAG	80	100	10	BI	ACM	TB
02667BRGP	BRG	57,2	77,8	10	BI	ACM	TB
02669GA	GA	17	25	4	LI	NBR	TB
02671BRGF	BRG	75	100	10	BI	FPM	TB
02672BRG	BRG	30	72	6,5	BI	NBR	A
02673BRX	BRX	57	85	13	LI	NBR	G
02675BRG	BRG	40	82,9	10	BI	NBR	TB
02677BRG	BRG	70	85	8	LI	NBR	TB
02678BRGS	BRG	30	47	7	H	MVQ	TB
02679BRG	BRG	145	175	14	LI	NBR	TB

Nº SABÓ	Tipo	Diám. Eixo	Diám. Alojamento	Altura Retentor	Orientação	Material Lábio	Grupo
02681BRAGF	BRAG	29,9	42	7	H	FPM	TB
02682BRAGF	BRAG	42	55	10	AH	FPM	TB
02685BR	BR	60	90	8	LI	NBR	TB
02686BRGEP	BRGE (67)	63,5	98,5	17,9	H	ACM	L
02687BRGEP	BRGE (67)	76,3	125,4	16,5	BI	NBR / ACM	L
02689BAG	BAG	12	20	5	LI	NBR	TB
02690BRG	BRG	95	115	13	BI	NBR	TB
02693BRGE	BRGE (12)	54	80	11,1/16,6	BI	NBR	B
02696BRAGF	BRAG	105	130	12	H	FPM	TB
02697BRAGF	BRAG	120	140	13	AH	FPM	TB
02699BRG	BRG	32	52	7	LI	NBR	TB
02701BRG	BRG	17	28	5	LI	NBR	TB
02702BRAGF	BRAG	80	98	10	AH	FPM	TB
02707GAE	GAE	37	45	12	LI	NBR	A
02713BRY	BRY (68)	121,1	160,2	30	BI	NBR	M
02716BAEF	BAE (79)	19	50,8	1,7/7,7	LI	FPM	O
02723BAF	BA	48	75	8	H	FPM	TB
02727BRG	BRG	25	52	8	LI	NBR	TB
02728BRGE	BRGE (04)	28	52	6,0/9,0	AH	NBR	A
02730BRG	BRG	17	30	7	LI	NBR	TB
02740BRGP	BRG	21,8	35	7	H	ACM	TB
02741BRGGP	BRGG	40	60	10,0/11,5	BI	ACM	A
02744GY	GY	30	52	10	LI	NBR	M
02745BRG	BRG	45	60	7	LI	NBR	TB
02753BRGF	BRG	75	95	13	LI	FPM	TB
02778B	B	145	175	13	BI	NBR	TB
02786BREF	BRE (107)	12	16,2	14,2	LI	FPM	F
02792BAG	BAG	12	28,1	8	LI	NBR	TB
02794BRAGF	BRAG	38	50	8	H	FPM	TB
02797BRGEF	BRGE (57)	25	38	10,5/14,5	LI	FPM	K
02801BAF	BA	85	105	10	AH	FPM	TB
02804BAGE	BAGE (42)	88,9	152,4	30,4	LI	NBR	A
02813BRG	BRG	30	52	8	LI	NBR	TB
02817BRAGF	BRAG	30	50	7	H	FPM	TB
02821BRG	BRG	20	35	6	LI	NBR	TB
02822BRG	BRG	40	52	6	LI	NBR	TB
02833BAGG	BAGG	48	65,5	7	LI	NBR	TB
02836BAGEF	BAGE (61)	35	54,9	9/14,7	BI	FPM	K
02837BAGF	BAG	23	35	8	H	FPM	TB
02842BRGF	BRG	32	47	10	H	FPM	TB
02844BRAGF	BRAG	40	56	7	H	FPM	TB
02845BRAGF	BRAG	70	85	8	AH	FPM	TB
02853BAGEF	BAGE (238)	63,5	102,5	7	H	FPM	A
02859BRGHF	BRGH (203)	40	55	8,8	LI	NBR / FPM / NY	A
02862BRAGF	BRAG	44,7	61,2	8,8	H	FPM	TB
02868BRG	BRG	125	150	13	BI	NBR	TB

Nº SABÓ	Tipo	Diám. Eixo	Diám. Alojamento	Altura Retentor	Orientação	Material Lábio	Grupo
02871BRAGF	BRAG	78	100,1	12	H	FPM	TB
02872BRAGF	BRAG	130,4	160	12	AH	FPM	TB
02876GRG	GRG	16,5	25	5	LI	NBR	A
02877BAG	BAG	28,6	41,3	6,5	H	NBR	TB
02894BY	BY	106,5	140	15	BI	NBR	M
02900BRAGF	BRAG	90	104	11	AH	FPM	TB
02910BAGE	BAGE	44,2	71,4	10,0/16,5	H	NBR	B
02919BREF	BRE (108)	7	10,9	9,5	LI	FPM	F
02927BREF	BRE (107)	8,7	13,5	11	LI	FPM	F
02929BRGE	BRGE (40)	30	62,9	2,5/20,2	LI	NBR	A
02930BRGP	BRG	30	47	10	BI	ACM	TB
02933BRG	BRG	150	180	15	LI	NBR	TB
02938BRAG	BRAG	95	115	13	BI	NBR	TB
02941BRAG	BRAG	125	150	15	BI	NBR	TB
02941BRAGF	BRAG	125	150	15	BI	FPM	TB
02952BAGEP	BAGE	21,8	85	48,4	H	ACM	T
02960BAGEP	BAGE (60)	47,6	68	10,4	H	ACM	K
02961BAGGP	BAGG	70	90	12,7	AH	ACM	A
02962BRGF	BRG	35	47	7	BI	FPM	TB
02963BROF	BRO	17	30	7	LI	FPM	A
02972BAG	BAG	40	55	8	BI	NBR	TB
02984BRG	BRG	32	45	7	LI	NBR	TB
02987GR	GR	32	45	6,5	LI	NBR	TB
02990BAGP	BAG	47,6	63,6	9,7	H	ACM	TB
02991BAGGP	BAGG	63,5	82,5	12,7	AH	ACM	A
02997BRGEP	BRGE	90	115	4,1/13	AH	ACM	B
03003GRE	GRE	20	30	4	LI	NBR	A
03004BRG	BRG	20	38	6	AH	NBR	TB
03009BREF	BRE	23,3	29,7	1,8/4,3	LI	FPM	B
03013BA	BA	20	31	7	LI	NBR	TB
03019BRAGEP	BRAGE (185)	22	40	8	H	ACM	A
03025BRGF	BRG	25	35	6	H	FPM	TB
03044BREF	BRE (101)	7	9,8	9,6/10	LI	FPM	F
03045BREF	BRE (111)	9,5	14,4	9,1/13,2	LI	FPM	F
03161BA	BA	41,1	50,8	5,9	LI	NBR	TB
03202GAE	GAE (87)	11,8	28	5,0/7,5	LI	HNBR	B
03248BRO	BRO	35	48	11	LI	NBR	A
03249BRO	BRO	31	43	11	LI	NBR	A
03252BR	BRG	14	22	5	BI	NBR	TB
03253BRG	BRG	17	27	5	LI	NBR	TB
03255BR	BR	12	21	4	LI	NBR	TB
03260BRGGE	BRGGE (125)	30	63	15	LI	NBR	A
03267GA	GA	10	15	3	LI	NBR	TB
03275GAO	GAO (244)	48,7	58	8,5	LI	NBR	A
03321BRG	BRG	55	75	8	LI	ACM	TB
03366BRO	BRO	30	40	10	LI	NBR	A
03389BRG	BRG	13,8	24	5	LI	NBR	TB
03391BRO	BRO	41	54	11	LI	NBR	A

Nº SABÓ	Tipo	Diâm. Eixo	Diâm. Alojamento	Altura Retentor	Orientação	Material Lábio	Grupo	Nº SABÓ	Tipo	Diâm. Eixo	Diâm. Alojamento	Altura Retentor	Orientação	Material Lábio	Grupo
03392BRO	BRO	37	50	11	LI	NBR	A	05414BRAGF	BRAG	155	180	15	AH	FPM	TB
03477BA	BA	17	28	7	H	NBR	TB	05420BRGF	BRG	90	110	9	AH	FPM	TB
03478BRAGF	BRAG	58	72	7	H	FPM	TB	05421BRGF	BRG	101,6	125	13	AH	FPM	TB
04247BRGF	BRG	36	50	8	H	FPM	TB	05502GHSI	GHSI	85	-	13	AH	PTFE	T
05055BRAGF	BRAG	64	80	9	H	FPM	TB	05507BRS	BR	30	42	8	H	MVQ	TB
05062BRAGF	BRAG	64	80	8	AH	FPM	TB	05508BRS	BR	35	47	7	H	MVQ	TB
05073BRAGF	BRAG	30	52	7	H	FPM	TB	05509BRGP	BRG	90	110	13	HO	MVQ	TB
05074BRAGF	BRAG	30	43	8	H	FPM	TB	05510BRGF	BRG	42	62	7	H	FPM	TB
05075BRAGF	BRAG	74	90	10	AH	FPM	TB	05511BRGF	BRG	35	50	8	BI	FPM	TB
05091BRGF	BRG	94,9	115	10	AH	FPM	TB	05513KIT	KIT (sem figura)						I
05093BRAGF	BRAG	30	42	7	H	FPM	TB	05516BRGS	BRG	25	42	8	H	MVQ	TB
05117BRG	BRG	30	42	6	BI	NBR	TB	05518KIT	KIT (sem figura)						I
05126BRF	BRG	60	76,2	11,1	AH	FPM	TB	05529BRGP	BRG	32	48	8	H	ACM	TB
05141BRA	BRA	17	28	7	LI	NBR	TB	05530BRGP	BRG	30	44	7	H	ACM	TB
05142BRA	BRA	20	31	7	LI	NBR	TB	05531BRGS	BRG	30	40	7	H	MVQ	TB
05142BRA	BRA	20	31	7	LI	NBR	TB	05536GRAGH	GRAGH	75	93	8	H	PTFE	S
05148BRF	BR	12,4	19	5	BI	FPM	TB	05537BRAGF	BRAG	55	70	8	H	FPM	TB
05155GRAHF	GRAH	115	140	13	AH	PTFE	S	05545MEH	MEH	53,7	67,7	7	LI	PTFE	S
05159BRAGF	BRAG	32	42	7,0 / 8,0	H	FPM	TB	05548BRGF	BRG	11,9	24	6	H	FPM	TB
05166BRAGF	BRAG	79	95,3	11	AH	FPM	TB	05578BRGF	BRG	130	160	14	AH	FPM	TB
05167BRAGEF	BRAGE (137)	36,6	52,4	8	H	FPM	A	05580BRGF	BRG	32	44	6	H	FPM	TB
05184GRAHF	GRAH	100	130	12	H	PTFE	S	05586BRGP	BRG	18,9	30	5,3	AH	ACM	TB
05198SIST	FLANGE	64	0	0	AH	FPM	T	05590BRGF	BRG	85	105	9	AH	FPM	TB
05202BRAGP	BRAG	30	47	7	H	ACM	TB	05591BRGF	BRG	42	66	6	H	FPM	TB
05214GRAHF	ACM	78	104	11	H	PTFE	S	05599BRGF	BRG	70	86	7	AH	FPM	TB
05239GHSIF	GHSIF	99,5	108	19	AH	PTFE	T	05601BRGF	BRG	80	100	8	AH	FPM	TB
05245MJEF	MJEF	74	0	0	AH	FPM	T	05603KIT	KIT (sem figura)	63,5	79,5	8	H	PTFE	I
05246BRAGF	BRAG	40	55	7	H	FPM	TB	05604KIT	KIT (sem figura)	75	93	8	H	PTFE	I
05250BRGF	BRG	42	53	7	H	FPM	TB	05651SIST	FLANGE	114	0	0	AH	PTFE / ACM	T
05253BRGF	BRG	35	50	7	H	FPM	TB	05652SIST	FLANGE	70	0	0	H	PTFE / ACM	T
05254BRGF	BRG	88	108	10,1	AH	FPM	TB	05658BRS	BR	35	47	7	H	MVQ	TB
05266BRAGF	BRAG	27	37	7	H	FPM	TB	05675BRGF	BRG	80	100	10	H	FPM	TB
05269BRAGF	BRAG	27	42	8,1	H	FPM	TB	05679GRAGH	ACM	120	140	13	H	PTFE	S
05287GRAGH	GRAGH (148)	130	150	12	AH	PTFE	S	05680GRAHF	ACM	145	175	13	AH	PTFE	S
05287KIT	KIT (sem figura)	130	150	12	AH	PTFE	I	05683BRG	BRG	50	70	10	H	FPM	TB
05302BRS	BR	80	100	13	AH	MVQ	TB	05699IOSS	IOSS	85	0	0	AH	PTFE	T
05304BRAGF	BRAG	85,7	114,3	13	H	FPM	TB	05702KIT	KIT (sem figura)	40	62	7,4	H	PTFE	I
05305BRGF	BRG	58	74	10	AH	FPM	TB	05725BRAGF	BRAG	180	205	15	AH	FPM	TB
05306BRGS	BRG	50	68	10	H	MVQ	TB	05772GAHFE	GAHFE	74	0	0	AH	PTFE	T
05307BRGP	BRG	34	48	7	H	ACM	TB	05774BRGF	BRG	42	60	10	H	FPM	TB
05308BRGP	BRG	50,8	69,9	11	H	ACM	TB	05775BRGF	BRG	44	60	7	H	FPM	TB
05309BRGP	BRG	53	69,9	11	H	ACM	TB	05776BRGF	BRG	80	96	9	AH	FPM	TB
05313BRGS	BRG	35	50	10	H	MVQ	TB	05780BRGP	BRG	28	47	8	H	ACM	TB
05338PHSI	PHSI	79	-	21	AH	PTFE	T	05782BRGP	BRG	37	50	6	H	ACM	TB
05352BRGF	BRG	57	71	9	H	FPM	TB	05783BRGF	BRG	86	103	7	AH	FPM	TB
05353BRGF	BRG	46,7	62	9	H	FPM	TB								
05363BRGF	BRG	37	47	10,2	H	FPM	TB								
05413GRGG	GRGG	57,5	74	8,5	LI	NBR	A								

Nº SABÓ	Tipo	Diâm. Eixo	Diâm. Alojamento	Altura Retentor	Orientação	Material Lábio	Grupo
05784BRGP	BRG	32	46	6	H	ACM	TB
05794BRGE	BRGE (13)	50	68	9	H	FPM	A
05795BRG	BRG	28	42	7	H	NBR	TB
05796BRGEF	BRGE (13)	95	115	9,5	AH	FPM	A
05801IOSS	IOSS	85	0	0	AH	PTFE	T
05809BRGF	BRG	45	67	8	H	FPM	TB
05813BSI	BSI	93	0	0	AH	FPM	T
05815BRGP	BRG	70	90	10	AH	ACM	TB
07002GRGH	GRG(225)	15	24	6	LI	HNBR	A
07021BRGP	BRG	40	55	8	H	ACM	TB
07023GA	GA	53	82	7,5	LI	NBR	TB
07074NE	NE	50	76	6	LI	NBR	N
07075GRE	GRE (152)	48	77	7,7	LI	NBR	A
07137BGEP	BGE	22,8	40	6,5/8	H	ACM	A
07138BAGEP	BAGE	29,8	52	10,0/13,5	AH	ACM	B
07139BAGEP	BAGE	29,8	50	10,0/13,5	H	ACM	B
07199BAGEP	BAGE	38,1	60,3	12,7/15,9	AH	ACM	B
07240BAGEP	BAGE	21,8	35	54,9 / 31	H	ACM	T
07262BAGGP	BAGG (145)	57,2	82,5	12	AH	ACM	A
07281BAGE	BAGE	145	170	15/20,6	LI	NBR	B
07284BRAGP	BRAG	40	55	8	BI	ACM	TB
07286BRP	BR	21,5	40	7	H	ACM	TB
07290BRAGF	BRAG	75	95	10	BI	FPM	TB
07291BRAGF	BRAG	95	115	13	BI	FPM	TB
07299BA	BA	30	58,1	11	AH	NBR	TB
07300BY	SIST.BY	39,9	68,9	15,4	BI	NBR	T
07309BRAGP	BRAG	22,8	40	8	H	ACM	TB
07312BR	BR	117,4	142,9	12,5	LI	NBR	TB
07319BRAGF	BRAG	120	145	15	BI	FPM	TB
07328BRGP	BRG	18	30	6,4	LI	ACM	TB
07338BAYF	BAY	121,1	160,2	35	BI	NBR/FPM	M
07340BAYF	BAY	121,1	160	35	BI	FPM	M
07351BRGEP	BRGE (139)	21,5	48	8,4	H	ACM	A
07365BRAGF	BRAG	45	65	10	H	FPM	TB
07366BRGP	BRG	48	62	7	BI	ACM	TB
07375BY	BY	82,5	114,3	12,7	BI	NBR	M
07395BARGG	BRAGGG (133)	47,7	73,1	17,5	BI	NBR	A
07408BRGP	BRG	11,6	24	10	LI	ACM	TB
07409BRP	BR	17	29	5,4	AH	ACM	TB
07425GAGGE	GAGGE	61,5	76,2	7,8	LI	NBR	A
07439BYF	BY	82,5	114,3	12,7	BI	FPM	M
07451BRP	BR	24	38	6	H	ACM	TB
07453BRAGP	BRAG	60	75	8	BI	ACM	TB
07458BRGP	BRG	21,9	40	8	H	ACM	TB
07459BRGGF	BRGG	50	65	10	***	FPM	A
07460MRP	MR (C)		40	0	***	ACM	H

Nº SABÓ	Tipo	Diâm. Eixo	Diâm. Alojamento	Altura Retentor	Orientação	Material Lábio	Grupo
07461BRF	BR	117,4	142,9	12,5	LI	FPM	TB
07465BRAF	BRA	8	14	4	LI	FPM	TB
07475BRABGE	BRABGE (131)	85	145	37	BI	FPM/NBR	L
07481BRABGE	BRABGE	40	70	0,5	BI	FPM / ACM	L
07484BRAGF	BRAG	60	73	10,5	BI	FPM	TB
07485BAF	BA	48	69	10	H	FPM	TB
07518BRG	BRG	15	26	7	LI	NBR	TB
07519BR	BR	16	22,8	4,8	LI	NBR	TB
07538BRAGEP	BRAGE	29,8	52	10,0/13,5	AH	ACM	B
07539BRAGEP	BRAGE	29,8	50	10,0/13,5	H	ACM	B
07552BAGE	BAGE (60)	73	98,5	11	BI	NBR	K
07598BRAGF	BRAG	36	54	7	H	FPM	TB
07599BAF	BA	46	68	12	H	FPM	TB
07603BRAF	BRA	68	85	10	H	FPM	TB
07612BAF	BA	48	69	10	H	FPM	TB
07630BY	BY	40	69	15,4	BI	NBR	M
07679SP	SP	17,5	50,4	21,5	LI	ACM	R
07683GAG	GAG	40	55	6	LI	NBR	A
07684GR	GR	70	81,5	6	LI	NBR	TB
07686GAE	GAE (117)	86	99	6,7	LI	NBR	A
07687BAG	BAG	33	44	8	LI	NBR	TB
07688BGE	BGE	62	85	8,5	LI	NBR	A
07689BRE	BRE (39)	35	41	6	LI	NBR	A
07691BAF	BA	55	75	8	H	FPM	TB
07695BAG	BAG	35	55	8	BI	NBR	TB
07696BRGEP	BRGE (124)	40	75	12,0/17,0	H	ACM	B
07699BRG	BRG	48	70	9	BI	NBR	TB
07700BAG	BAG	52	70	9	BI	NBR	TB
07701BARG	BARG (105)	47,7	73,1	9,5/12,0	BI	NBR	B
07716BAGE	BAGE (237)	72	85,5	18	BI	NBR	A
07717BRGP	BRG	40	55	10	H	ACM	TB
07735BRAYF	BRAY	70	99	13	BI	FPM	M
07745BAGEP	BAGE (102)	38,1	54,1	12,7/16,0	AH	ACM	B
07781GAEP	GAE	40	66	7	LI	ACM	G
07790BY	BY	142	170	14	BI	NBR	M
07807SP	SP	17,5	50,4	21,5	LI	ACM	R
07808BRAGGF	BRAGG	62	78	10	AH	FPM	A
07809BRAGF	BRAG	46	64	8	H	FPM	TB
07820BAG	BAG	50	65	9	LI	NBR	TB
07822BAG	BAG	69	85	10	LI	NBR	TB
07823BAG	BAG	63	80	12	BI	NBR	TB
07840BRAGF	BRAG	105	130	12	AH	FPM	TB
07868BAGGEF	BAGGE (60)	46,8	69,8	12	H	FPM	K
07877GAE	GAE	25	35	7	LI	HNBR	A
07880BRAGF	BRAG	50	65	8	AH	FPM	TB

Nº SABÓ	Tipo	Diâm. Eixo	Diâm. Alojamento	Altura Retentor	Orientação	Material Lábio	Grupo
07888GRP	GR	19	25,4	4,3	LI	ACM	TB
07919BGE	BGE (100)	110	140	13	BI	NBR	B
07920BGE	BGE (100)	95	120	15	BI	NBR	B
07923GAEP	GAE	70	80	8	LI	ACM	A
07959BRAGF	BRAGE (104)	145	175	17	BI	FPM	A
07967GA	GA	25	32	5	LI	NBR	TB
07970BGY	BGY (136)	136,8	165	13	BI	NBR	M
07982BRYF	BRY (68)	85	105	13	H	NBR/ FPM	M
07985BRY	BRY (68)	85	105	13	AH	NBR/ FPM	M
08312BRF	BR	40	52	7	H	FPM	TB
08313BRAAF	BR	48	65	10	H	FPM	TB
08314BGEF	BGE (135)	140	164	20	BI	FPM	A
08316BRY	BRY	75	100	10	LI	NBR	M
08318GRE	GRE (128)	77	98,5	8,5	LI	NBR	A
08383BRY	BRY (68)	121,1	160,2	30	BI	ACM / NBR	M
08392BRY	BRY	87	110	14,5	BI	FPM/ NBR	M
08397BRY	BRY	101	131	14	BI	FPM/ NBR	M
08398GY	GY	73	95	9,5	BI	FPM/ NBR	M
08427BRAGF	BRAG	70	88	10	AH	FPM	TB
09203BREF	BRE (101)	6	8,8	12,2	LI	FPM	F
09205BREF	BRE (101)	11	14	0,7	LI	FPM	F
09210BREF	BRE (107)	8,8	14,3	11	LI	FPM	F
09211BAEF	BAE	9	13	10	LI	FPM	F
09212BAEF	BAE	8	14	8	LI	FPM	F
09224BREF	BRE (107)	8,1	13	13,5	LI	FPM	F
09228BREF	BRE (101)	7	11	10,2	LI	FPM	F
09235BREF	BRE (110)	9	19	15,14	LI	FPM	F
09236BREF	BRE (110)	10	19	15,14	LI	FPM	F
09237BREF	BRE (108)	9	12	7	LI	FPM	F
09239BREF	BRE (101)	7	11	10,2	LI	FPM	F
09242BREF	BRE (101)	8	12	0,6	LI	FPM	F
09250BREF	BRE (91)	6	11	17,8	LI	FPM	F
09260BREF	BRE (91)	6	12	19,4	LI	FPM	F
09261BAEF	BAE	7	11,8	10	LI	FPM	F
09262BAEF	BAE	8	13	10	LI	FPM	F
09266NEF	NE (34)	5,5	9,2	8	LI	FPM	F
09271BAEF	BAE	8,5	14,1	13,5	LI	FPM	F
09282BAEF	BAE	10	12,8	10,2	LI	FPM	F
09283NEF	NE	5	8,5	6,6	LI	FPM	F
09284BREF	BRE (108)	8	12	7	LI	FPM	F
09285BREF	BRE (91)	9,4	16	28,1	LI	FPM	F
09286NOF	NO (112)	7,9	14	12,6	LI	FPM	F
09300BREF	BRE (101)	5	7,8	8	LI	FPM	F
09301BREF	BRE (101)	5,5	8,5	8	LI	FPM	F
09302BREF	BRE (91)	5,5	11	28	LI	FPM	F
09303BREF	BRE (101)	6	11	7,7	LI	FPM	F

Nº SABÓ	Tipo	Diâm. Eixo	Diâm. Alojamento	Altura Retentor	Orientação	Material Lábio	Grupo
10143GE	GE (52)	29,8	42,3	29,5	LI	NBR	A
10316MGE	MGE	2	24,5	14,7	LI	NBR	H
10409MR	MR (A)		27	7	LI	NBR	H
10410MR	MR (B)		27,5	7	0	NBR	H
10411MR	MR (A)		28	7	0	NBR	H
10415MRP	MR (A)		68	8,5	0	ACM	H
20083U	U (D)	15	21,5	3,2	LI	NBR	C
20145GE	GE	19,7	31,8	18	LI	NBR	N
20148G	G	7,2	19,3	3	0	0	N
20166U	U (B)	41	57	9,5	LI	NBR	C
20171U	U (B)	36	52	12	LI	NBR	C
20175U	U (B)	16	27	7,5	LI	NBR	C
20180G	G (B)	8,7	0	0,9/1,6	0	NBR	J
20181U	U (A)	16	22	6	LI	NBR	N
20202U	U (D)	8	14	4	LI	FPM	C
20205NEF	NE (74)	17	21,5	15	LI	FPM	N
20210UE	UE	157	170,3	19,5	LI	NBR	N